

Elettropompe centrifughe normalizzate "EN 733"

 Acque pulite

 Uso industriale

CAMPO DELLE PRESTAZIONI

- Portata fino a **6000 l/min** (360 m³/h)
- Prevalenza fino a **98 m**

LIMITI D'IMPIEGO

- Altezza d'aspirazione manometrica fino a **7 m**
- Temperatura del liquido da **-10 °C** fino a **+90 °C**
- Temperatura ambiente da **-10 °C** fino a **+40 °C**
- Pressione max. nel corpo pompa **10 bar** (PN10)
- Servizio continuo **S1**

ESECUZIONE E NORME DI SICUREZZA

EN 60335-1
IEC 60335-1
CEI 61-150

EN 60034-1
IEC 60034-1
CEI 2-3



Dimensioni corpo pompa secondo: **EN 733**

REGOLAMENTO (UE) N. 547/2012

CERTIFICAZIONI

Azienda con sistema di gestione certificato DNV
ISO 9001: QUALITÀ
ISO 14001: AMBIENTE



UTILIZZI E INSTALLAZIONI

- Approvvigionamento idrico
- Pressurizzazione
- Irrigazione
- Circolazione acqua in impianti di climatizzazione
- Impianti di lavaggio
- Impianti antincendio
- Industria
- Agricoltura

L'installazione è da effettuarsi in luoghi chiusi o comunque protetti dalle intemperie.

ESECUZIONI A RICHIESTA

- KIT controflange comprensivo di viti, dadi e guarnizioni
- Tenuta meccanica speciale
- Altre tensioni o frequenza a 60 Hz
- Per liquidi con temperature più alte o più basse
- Per ambienti con temperature più alte o più basse

GARANZIA

2 anni secondo le nostre condizioni generali di vendita

CAMPO DI PRESTAZIONI

50 Hz n = 2900 rpm

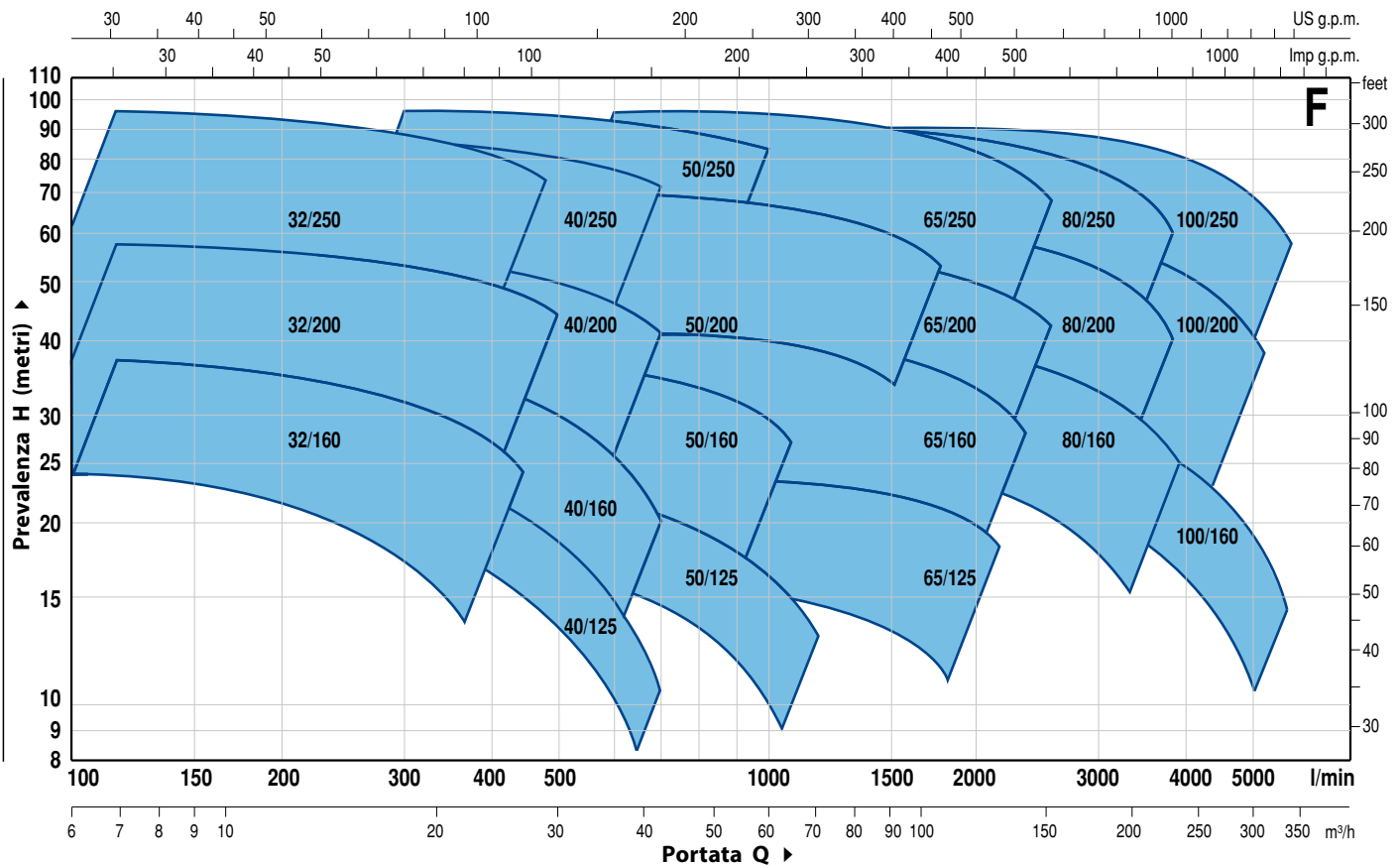

DATI DI PRESTAZIONI

50 Hz n = 2900 rpm

TIPO	POTENZA (P ₂)		▲	PRESTAZIONI	
	kW	HP		Q l/min	H metri
Trifase					
F 32/160C	1.5	2	IE3	100 ÷ 350	24 ÷ 14
F 32/160B	2.2	3		100 ÷ 400	30 ÷ 17
F 32/160A	3	4		100 ÷ 450	37 ÷ 24
F 32/200C	4	5.5	IE3	100 ÷ 450	44 ÷ 31.5
F 32/200B	5.5	7.5		100 ÷ 500	51 ÷ 36
F 32/200A	7.5	10		100 ÷ 500	57 ÷ 44
F 32/200BH	3	4	IE3	100 ÷ 300	45 ÷ 37
F 32/200AH	4	5.5		100 ÷ 320	55 ÷ 44
F 32/250C	9.2	12.5		100 ÷ 400	75 ÷ 55
F 32/250B	11	15	IE3	100 ÷ 450	87 ÷ 62
F 32/250A	15	20		100 ÷ 480	97 ÷ 70
F 40/125C	1.1	1.5		IE2	100 ÷ 550
F 40/125B	1.5	2	IE3	100 ÷ 600	20.5 ÷ 9
F 40/125A	2.2	3		100 ÷ 700	26 ÷ 10
F 40/160C	2.2	3		100 ÷ 600	27 ÷ 14
F 40/160B	3	4	IE3	100 ÷ 600	32 ÷ 20
F 40/160A	4	5.5		100 ÷ 700	38 ÷ 20
F 40/200B	5.5	7.5		100 ÷ 700	47 ÷ 28
F 40/200A	7.5	10	IE3	100 ÷ 700	55 ÷ 41
F 40/250C	9.2	12.5		100 ÷ 700	64 ÷ 47
F 40/250B	11	15		100 ÷ 700	71 ÷ 55
F 40/250A	15	20	IE3	100 ÷ 700	88 ÷ 72
F 50/125C	2.2	3		300 ÷ 1200	17.5 ÷ 6
F 50/125B	3	4		IE3	300 ÷ 1200
F 50/125A	4	5.5	300 ÷ 1200		23.5 ÷ 13
F 50/160C	4	5.5	300 ÷ 1000		27 ÷ 16
F 50/160B	5.5	7.5	IE3	300 ÷ 1100	32 ÷ 21
F 50/160A	7.5	10		300 ÷ 1100	37 ÷ 27
F 50/200C	11	15		400 ÷ 1700	44 ÷ 30
F 50/200B	15	20	IE3	400 ÷ 1700	52 ÷ 38
F 50/200A	18.5	25		400 ÷ 1800	61 ÷ 45
F 50/200AR	22	30		400 ÷ 1800	69 ÷ 53
F 50/250D	9.2	12.5	IE3	300 ÷ 900	51 ÷ 32
F 50/250C	11	15		300 ÷ 900	59 ÷ 42
F 50/250B	15	20		300 ÷ 1000	72 ÷ 59
F 50/250A	18.5	25	IE3	300 ÷ 1000	85 ÷ 73
F 50/250AR	22	30		300 ÷ 1000	95 ÷ 83

TIPO	POTENZA (P ₂)		▲	PRESTAZIONI	
	kW	HP		Q l/min	H metri
Trifase					
F 65/125C	4	5.5	IE3	600 ÷ 1800	16 ÷ 11
F 65/125B	5.5	7.5		600 ÷ 2000	18 ÷ 13
F 65/125A	7.5	10		600 ÷ 2200	23 ÷ 18
F 65/160C	9.2	12.5	IE3	600 ÷ 2200	32 ÷ 22
F 65/160B	11	15		600 ÷ 2400	36.5 ÷ 23
F 65/160A	15	20		600 ÷ 2400	40.5 ÷ 28
F 65/200B	15	20	IE3	200 ÷ 2400	44 ÷ 30.5
F 65/200A	18.5	25		200 ÷ 2500	50 ÷ 36.5
F 65/200AR	22	30		200 ÷ 2600	57 ÷ 42
F 65/250C	30	40	IE3	400 ÷ 2350	76 ÷ 53
F 65/250B	37	50		400 ÷ 2500	87 ÷ 62
F 65/250A	45	60		400 ÷ 2600	95 ÷ 68
F 80/160D	11	15	IE3	500 ÷ 4000	25 ÷ 10
F 80/160C	15	20		500 ÷ 4000	30 ÷ 15
F 80/160B	18.5	25		500 ÷ 4000	35 ÷ 20
F 80/160A	22	30	IE3	500 ÷ 4000	40 ÷ 25
F 80/200B	30	40		500 ÷ 3650	56 ÷ 34.5
F 80/200A	37	50		500 ÷ 3900	62 ÷ 40
F 80/250B	45	60	IE3	600 ÷ 3600	77 ÷ 54
F 80/250A	55	75		600 ÷ 3900	88.5 ÷ 60
F 100/160C-N	15	20		1000 ÷ 5000	28.5 ÷ 11
F 100/160B-N	18.5	25	IE3	1000 ÷ 5500	32.5 ÷ 11
F 100/160A-N	22	30		1000 ÷ 6000	37 ÷ 13
F 100/200C	30	40		833 ÷ 4650	51 ÷ 28
F 100/200B	37	50	IE3	833 ÷ 4900	57 ÷ 33
F 100/200A	45	60		833 ÷ 5250	63 ÷ 38
F 100/250B	55	75		800 ÷ 5150	75 ÷ 48
F 100/250A	75	100	IE3	800 ÷ 5750	89 ÷ 58

Q = Portata

H = Prevalenza manometrica totale

Tolleranza delle curve di prestazioni secondo EN ISO 9906 Grado 3B.

▲ Classe di rendimento del motore trifase (IEC 60034-30)

F32/160

CURVE E DATI DI PRESTAZIONE

50 Hz n= 2900 rpm HS= 0 m

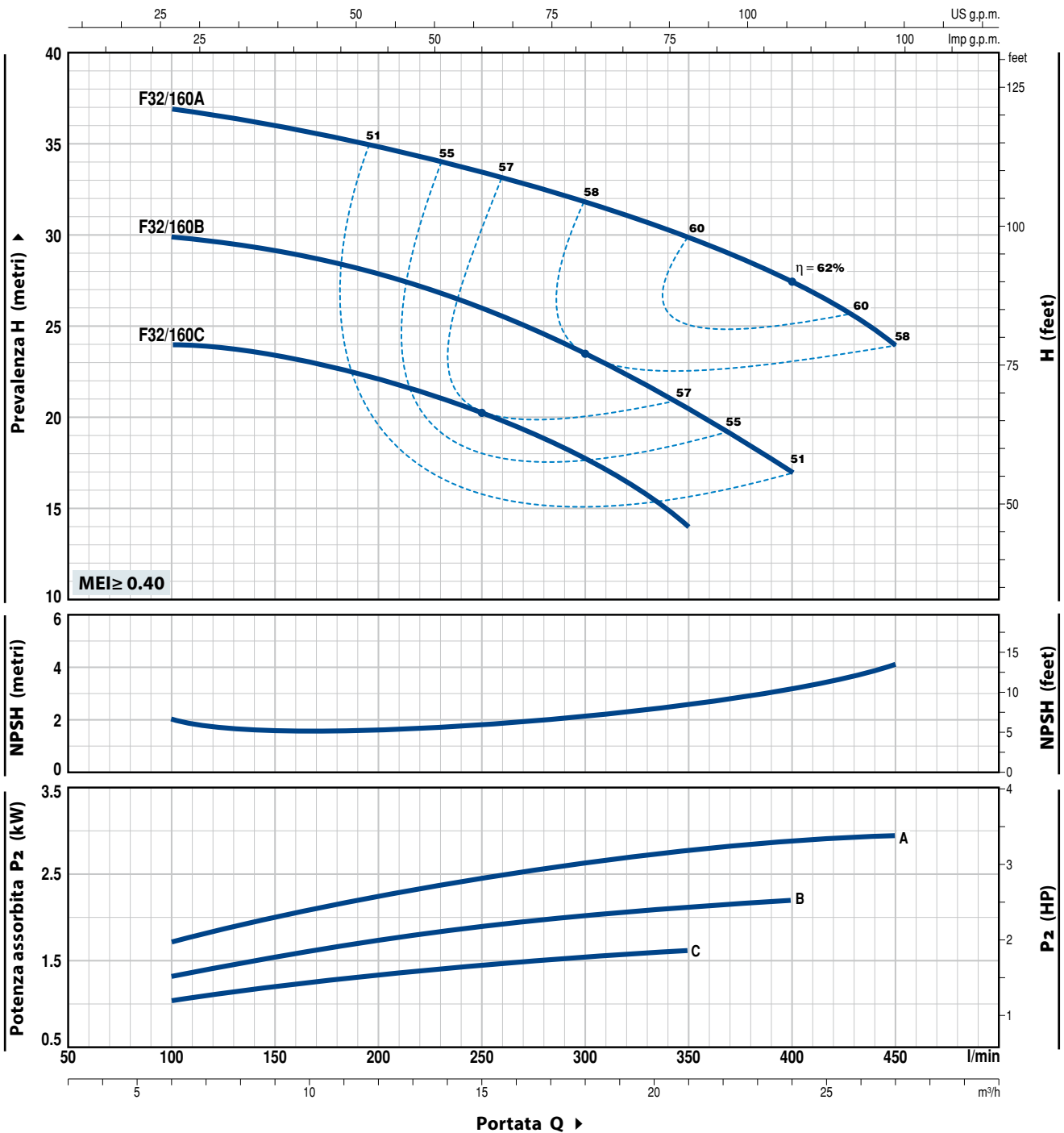

TIPO		POTENZA (P ₂)		Q	m ³ /h												
Monofase	Trifase	kW	HP		0	6	9	12	15	18	21	24	27				
				l/min	0	100	150	200	250	300	350	400	450				
Fm 32/160C	F 32/160C	1.5	2	H metri	25	24	23.5	22	20.5	18	14						
Fm 32/160B	F 32/160B	2.2	3		31	30	29	28	26	23.5	20.5	17					
-	F 32/160A	3	4		38	37	36	35	33.5	31.5	30	27.5	24				

Q = Portata H = Prevalenza manometrica totale HS = Altezza di aspirazione

Tolleranza delle curve di prestazione secondo EN ISO 9906 Grado 3B.

CURVE E DATI DI PRESTAZIONE

50 Hz n= 2900 rpm HS= 0 m

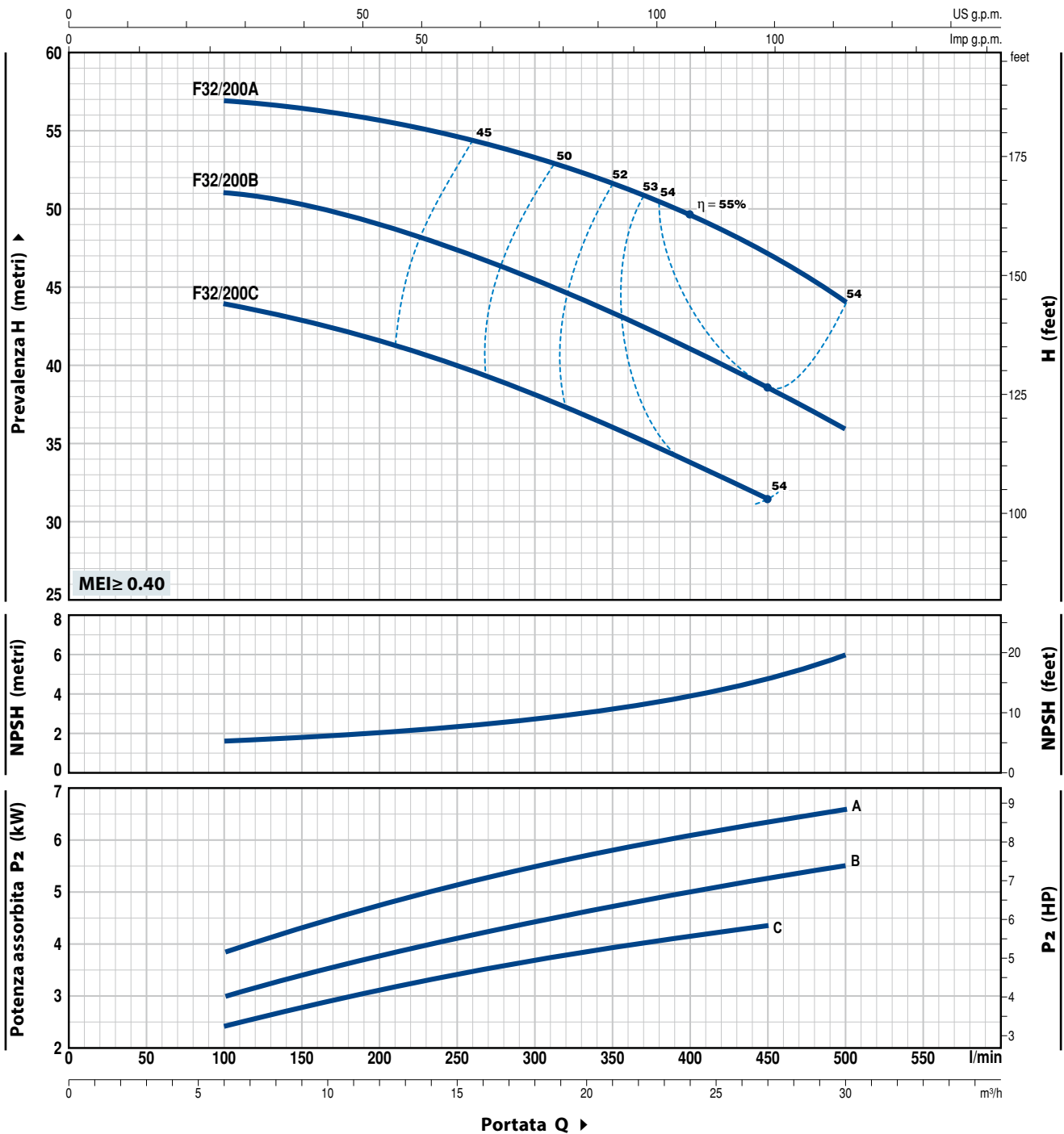

TIPO Trifase	POTENZA (P ₂)		Q m ³ /h l/min	0	6	9	12	15	18	21	24	27	30
	kW	HP		0	100	150	200	250	300	350	400	450	500
F 32/200C	4	5.5	H metri	46	44	43	41.5	40	38	36	34	31.5	
F 32/200B	5.5	7.5		52	51	50.5	49	47	45	43	41	38.5	36
F 32/200A	7.5	10		60	57	56.5	56	55	53.5	52	50	47	44

Q = Portata H = Prevalenza manometrica totale HS = Altezza di aspirazione

Tolleranza delle curve di prestazione secondo EN ISO 9906 Grado 3B.

F32/200H

CURVE E DATI DI PRESTAZIONE

50 Hz n= 2900 rpm HS= 0 m

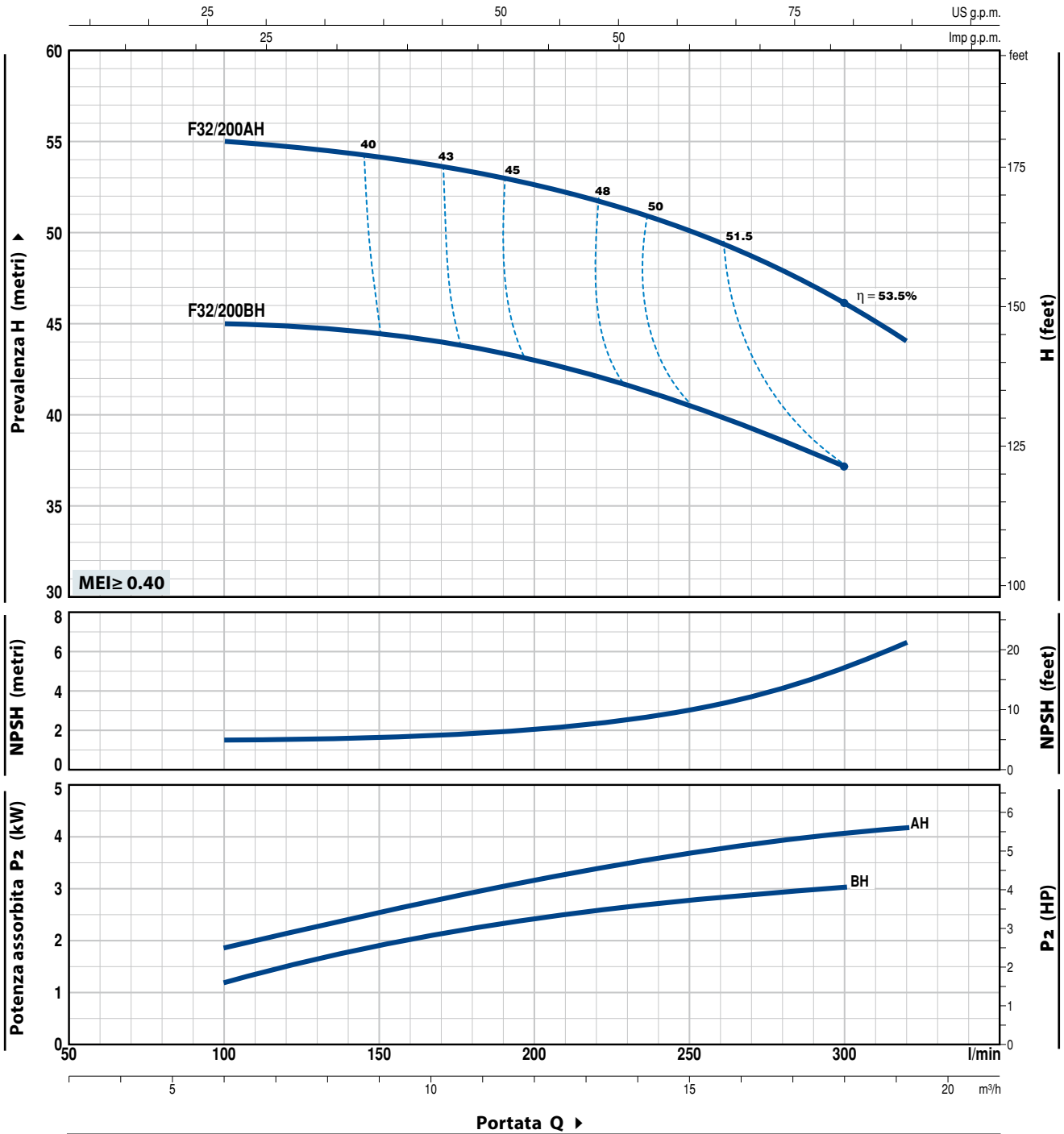

TIPO Trifase	POTENZA (P ₂)		Q m ³ /h l/min	0	6	9	12	15	18	19.2
	kW	HP		0	100	150	200	250	300	320
F 32/200BH	3	4	H metri	47	45	44.5	43	40.5	37	
F 32/200AH	4	5.5	H metri	57	55	54	52.5	50	46	44

Q = Portata H = Prevalenza manometrica totale HS = Altezza di aspirazione

Tolleranza delle curve di prestazione secondo EN ISO 9906 Grado 3B.

CURVE E DATI DI PRESTAZIONE

50 Hz n= 2900 rpm HS= 0 m

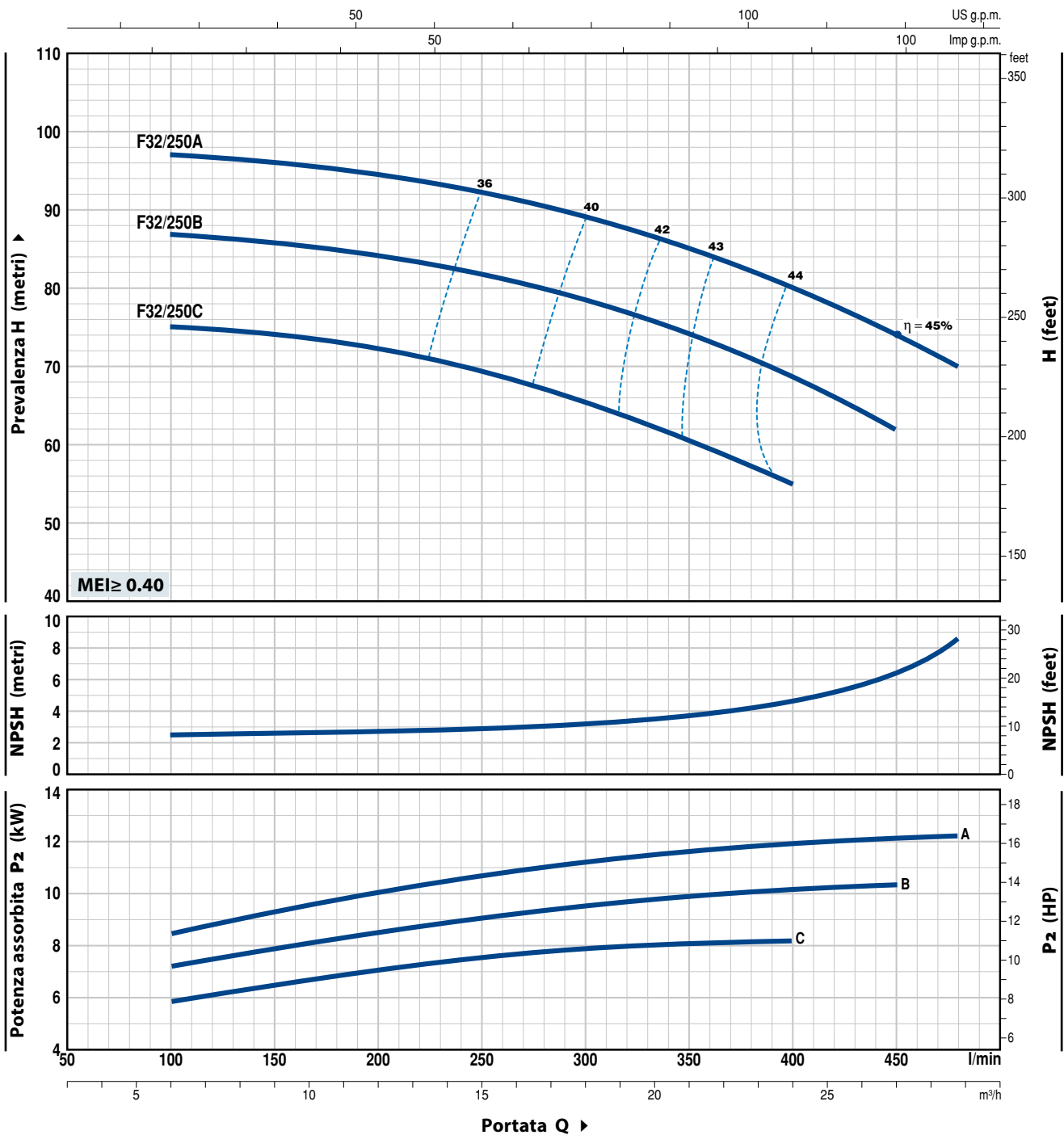

TIPO Trifase	POTENZA (P ₂)		Q m ³ /h l/min	0	6	9	12	15	18	21	24	27	28.8
	kW	HP		0	100	150	200	250	300	350	400	450	480
F 32/250C	9.2	12.5	H metri	76	75	74.5	72.5	69.5	66	61	55		
F 32/250B	11	15		88	87	86	84	82	78.5	74.5	69	62	
F 32/250A	15	20		98	97	96	94.5	92	89	85	80	74	70

Q = Portata H = Prevalenza manometrica totale HS = Altezza di aspirazione

Tolleranza delle curve di prestazione secondo EN ISO 9906 Grado 3B.

F40/125

CURVE E DATI DI PRESTAZIONE

50 Hz n= 2900 rpm HS= 0 m

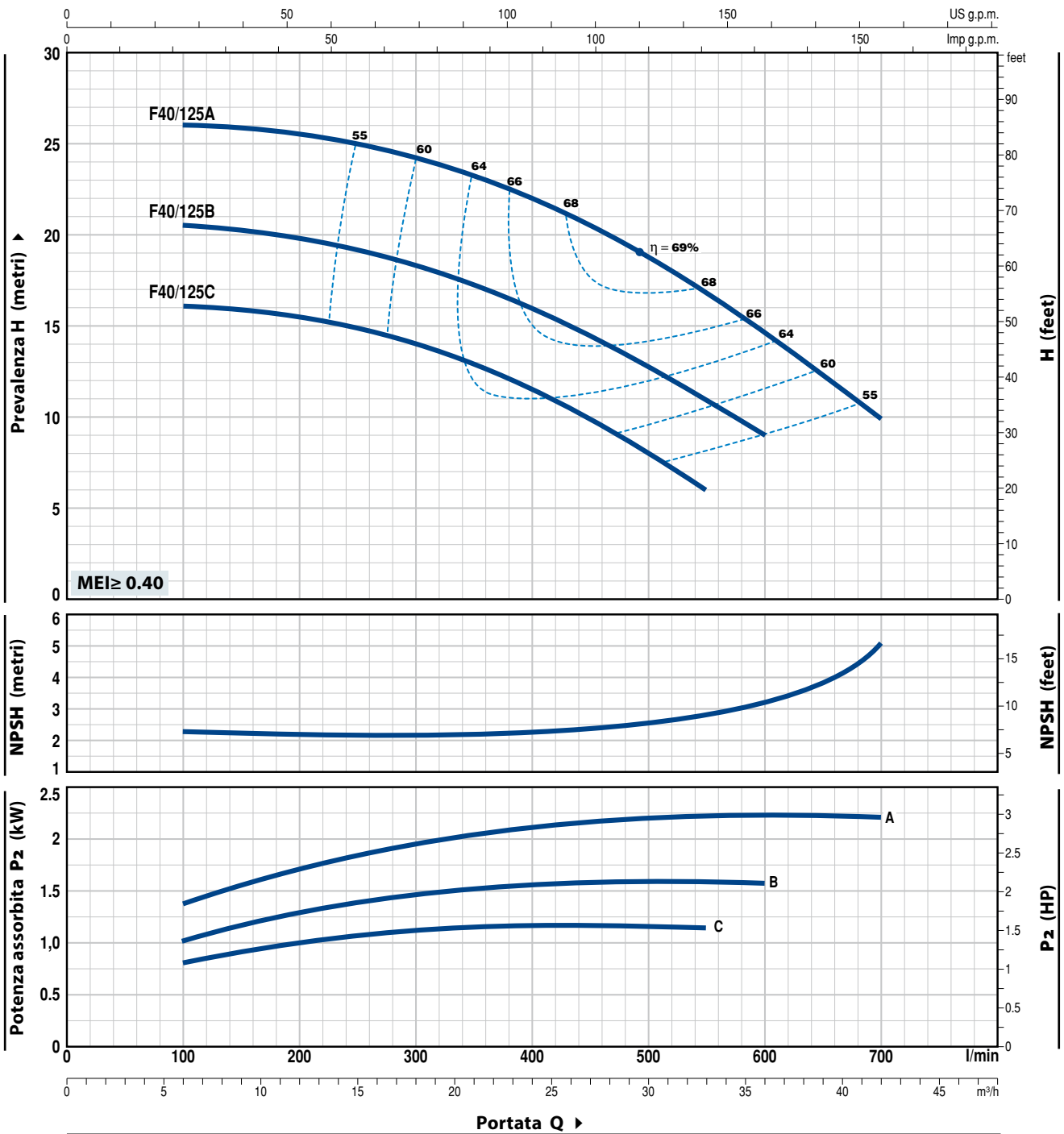

TIPO		POTENZA (P ₂)		Q	Flow Rate (m³/h)													
Monofase	Trifase	kW	HP		0	6	12	18	24	30	33	36	39	42				
Fm 40/125C	F 40/125C	1.1	1.5	H metri	0	100	200	300	400	500	550	600	650	700				
	Fm 40/125B	1.5	2		16	16	15.5	14	11.5	8	6							
-	F 40/125A	2.2	3		20.5	20.5	19.8	18.5	16	12.8	11	9						
					26	26	25.5	24	22	18.5	17	14.5	12.5	10				

Q = Portata H = Prevalenza manometrica totale HS = Altezza di aspirazione

Tolleranza delle curve di prestazione secondo EN ISO 9906 Grado 3B.

CURVE E DATI DI PRESTAZIONE

50 Hz n= 2900 rpm HS= 0 m

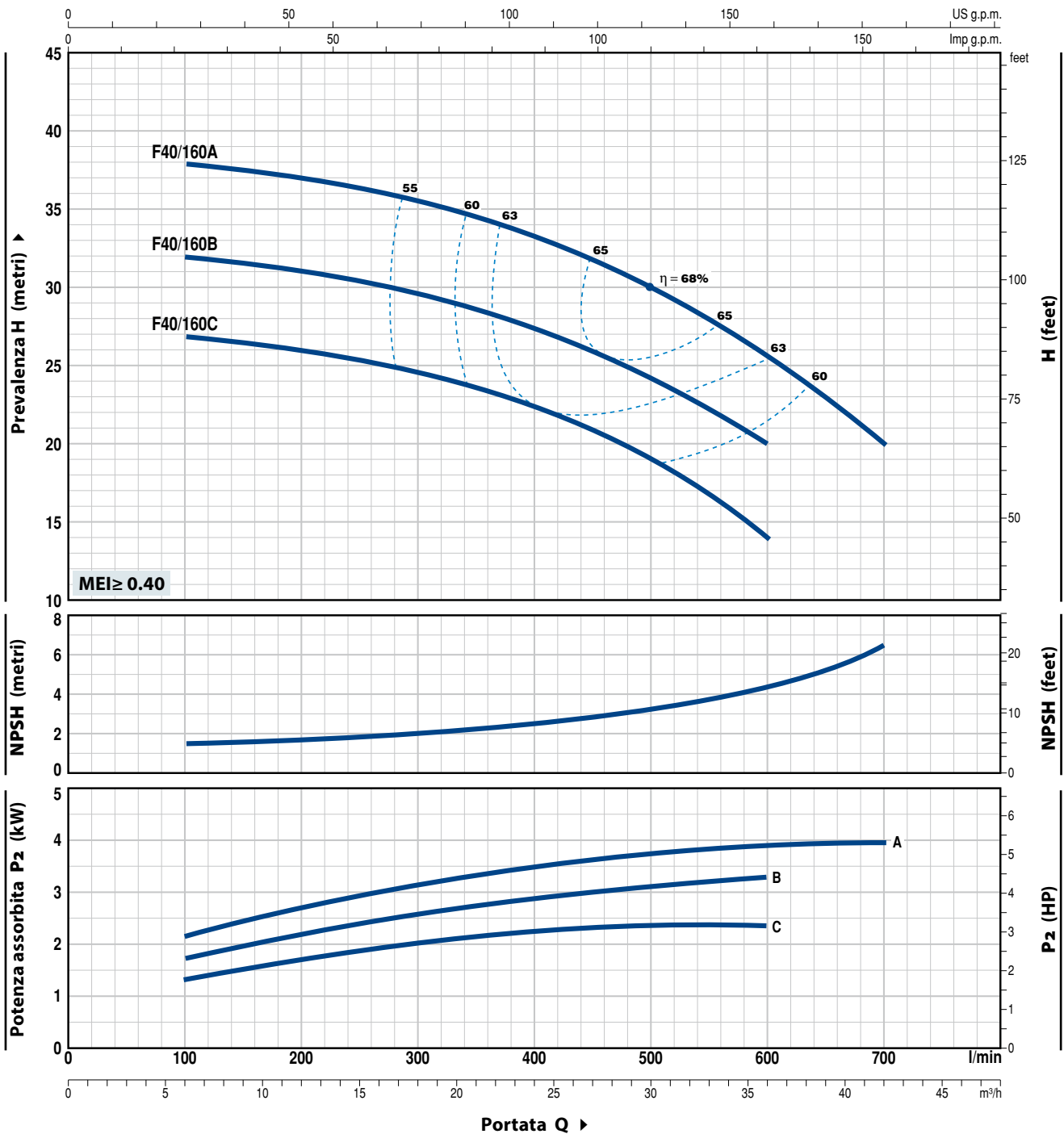

TIPO		POTENZA (P ₂)		Q	Flow (Q)													
Monofase	Trifase	kW	HP		m ³ /h	0	6	9	12	15	18	24	30	36	42			
				l/min	0	100	150	200	250	300	400	500	600	700				
Fm 40/160C	F 40/160C	2.2	3	H metri	27	27	26.5	26	25.5	25	22.5	19	14					
-	F 40/160B	3	4		32	32	31.5	31	30.5	30	27.5	24	20					
-	F 40/160A	4	5.5		38	38	37.8	37	36.5	36	33.5	30	26	20				

Q = Portata H = Prevalenza manometrica totale HS = Altezza di aspirazione

Tolleranza delle curve di prestazione secondo EN ISO 9906 Grado 3B.

F40/200

CURVE E DATI DI PRESTAZIONE

50 Hz n= 2900 rpm HS= 0 m

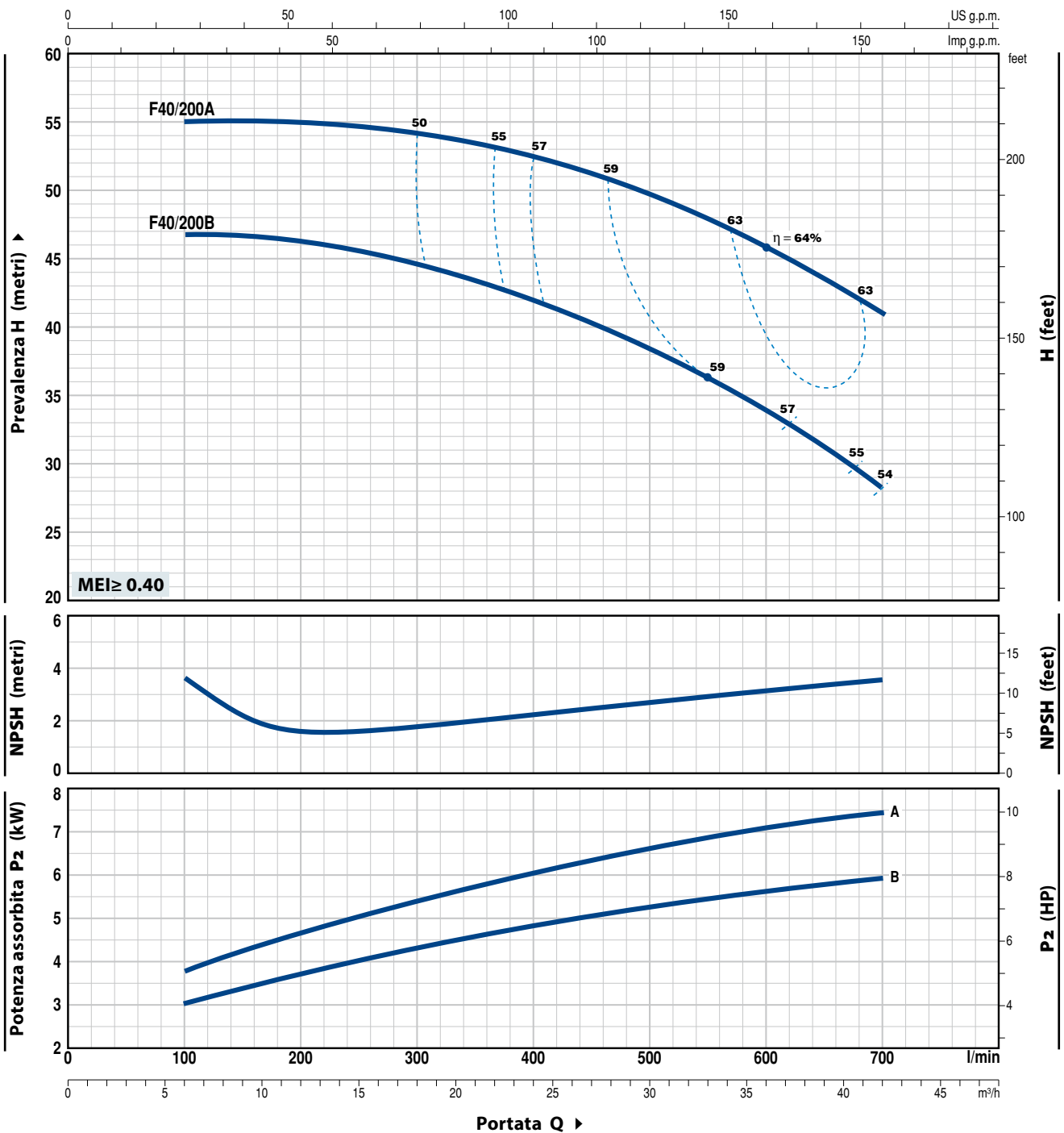

TIPO	POTENZA (P ₂)		Q	Flow Rate											
	kW	HP		0	6	9	12	15	18	24	30	36	42		
Trifase			l/min	0	100	150	200	250	300	400	500	600	700		
F 40/200B	5.5	7.5	H metri	48	47	46.5	46	45.5	44.5	42	38	34	28		
F 40/200A	7.5	10	H metri	56	55	55	55	54.5	54	52.5	49.5	46	41		

Q = Portata H = Prevalenza manometrica totale HS = Altezza di aspirazione

Tolleranza delle curve di prestazione secondo EN ISO 9906 Grado 3B.

CURVE E DATI DI PRESTAZIONE

50 Hz n= 2900 rpm HS= 0 m

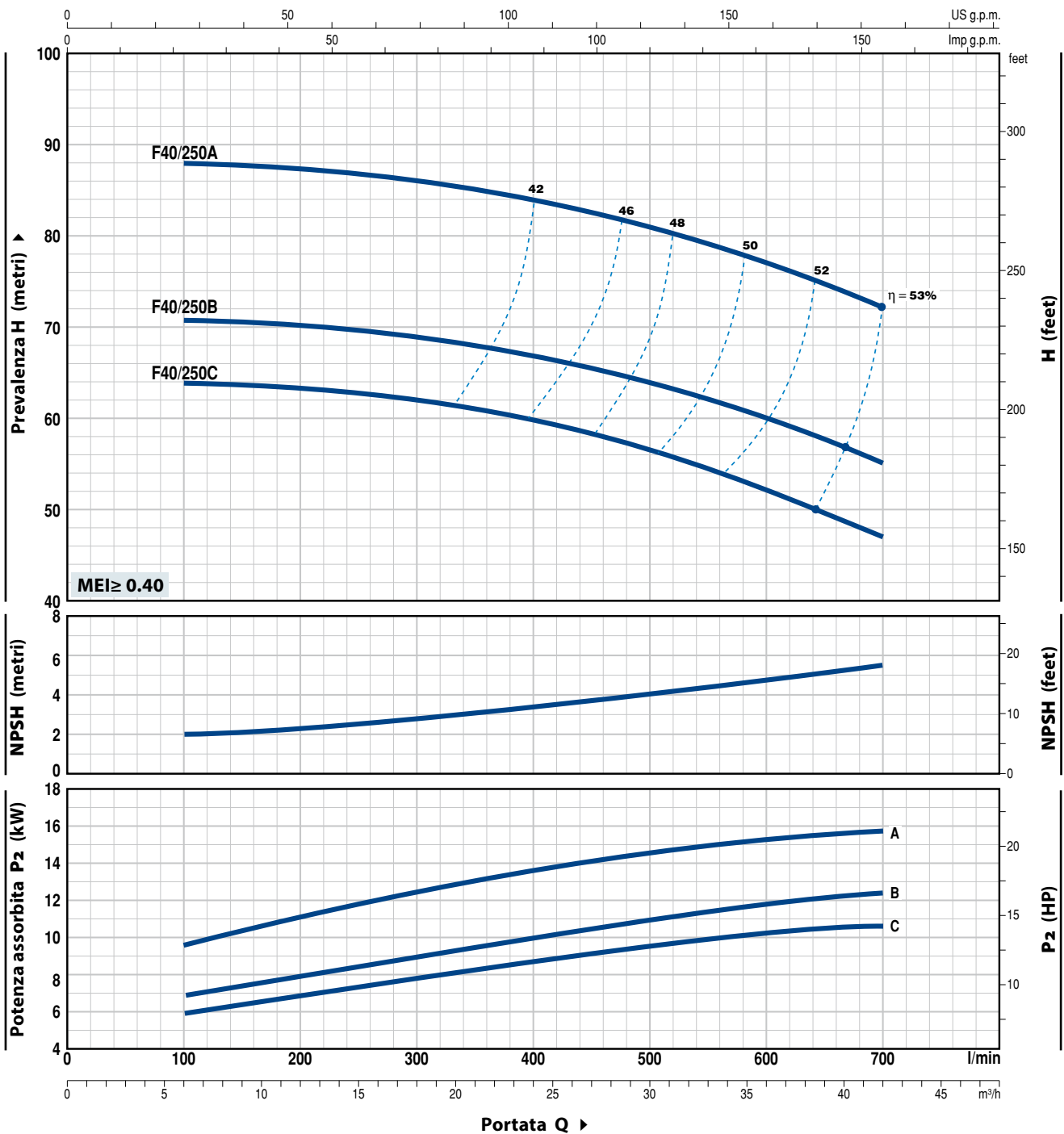

TIPO Trifase	POTENZA (P ₂)		Q m ³ /h l/min	0	6	9	12	15	18	24	30	36	42
	kW	HP		0	100	150	200	250	300	400	500	600	700
F 40/250C	9.2	12.5	H metri	64	64	63.5	63	62.5	62	60	56.5	52.5	47
F 40/250B	11	15		71	71	70.5	70	69.5	69	67	64	60	55
F 40/250A	15	20		88	88	87.5	87	86.5	86	84	81	77	72

Q = Portata H = Prevalenza manometrica totale HS = Altezza di aspirazione

Tolleranza delle curve di prestazione secondo EN ISO 9906 Grado 3B.

F50/125

CURVE E DATI DI PRESTAZIONE

50 Hz n= 2900 rpm HS= 0 m

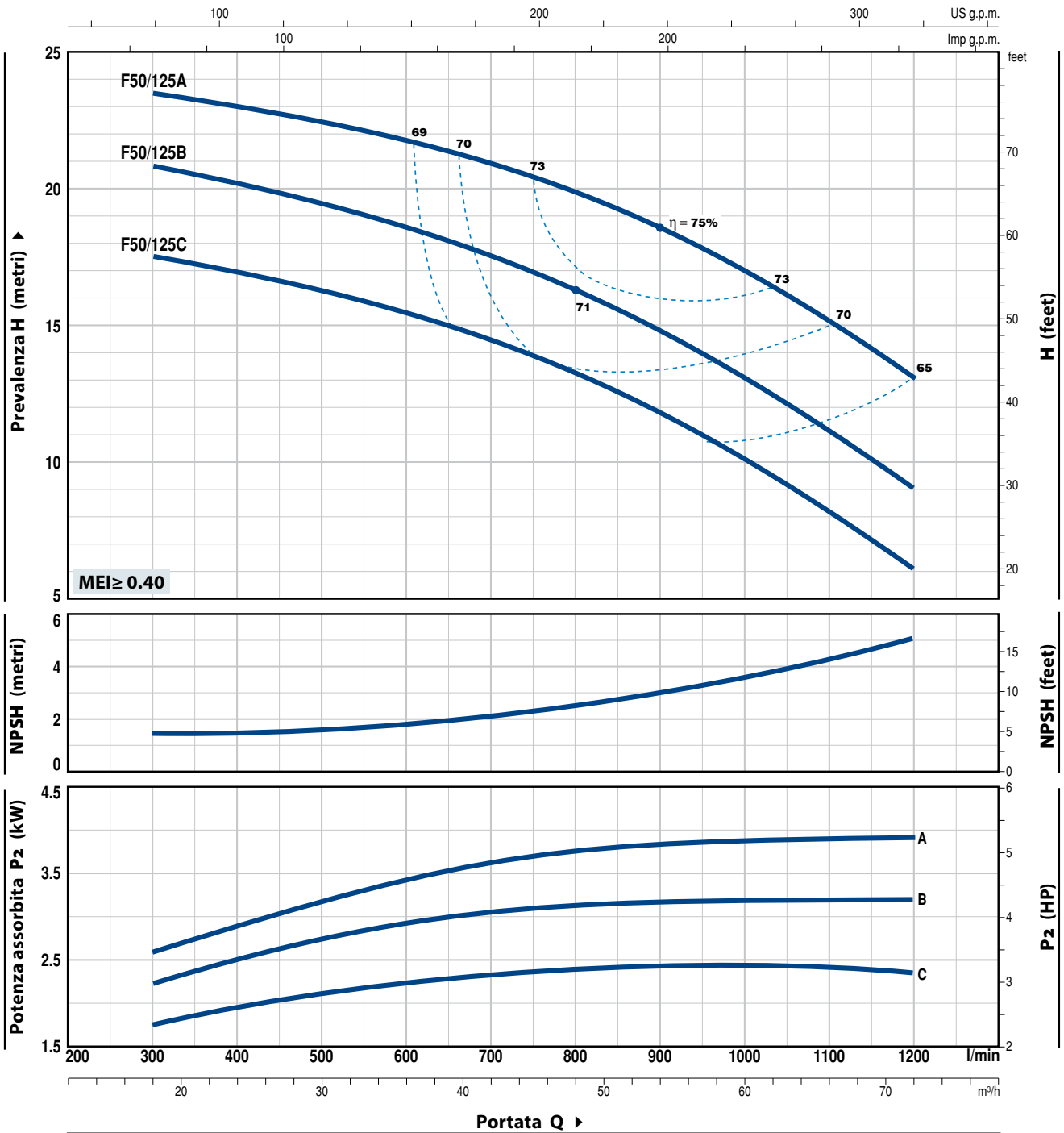

Monofase	TIPO	POTENZA (P ₂)		Q	Flow Rate (Q)												
		kW	HP		0	18	24	30	36	42	48	54	60	66	72		
	Trifase			l/min	0	300	400	500	600	700	800	900	1000	1100	1200		
Fm 50/125C	F 50/125C	2.2	3	H metri	18.5	17.5	17	16.5	15.5	14.8	13.5	12	10.5	8.2	6		
-	F 50/125B	3	4		21.5	20.7	20	19.5	18.8	17.8	16.5	15	13.5	11.2	9		
-	F 50/125A	4	5.5		24.5	23.5	23	22.5	21.8	20.8	19.5	18.3	16.8	15	13		

Q = Portata H = Prevalenza manometrica totale HS = Altezza di aspirazione

Tolleranza delle curve di prestazione secondo EN ISO 9906 Grado 3B.

CURVE E DATI DI PRESTAZIONE

50 Hz n= 2900 rpm HS= 0 m

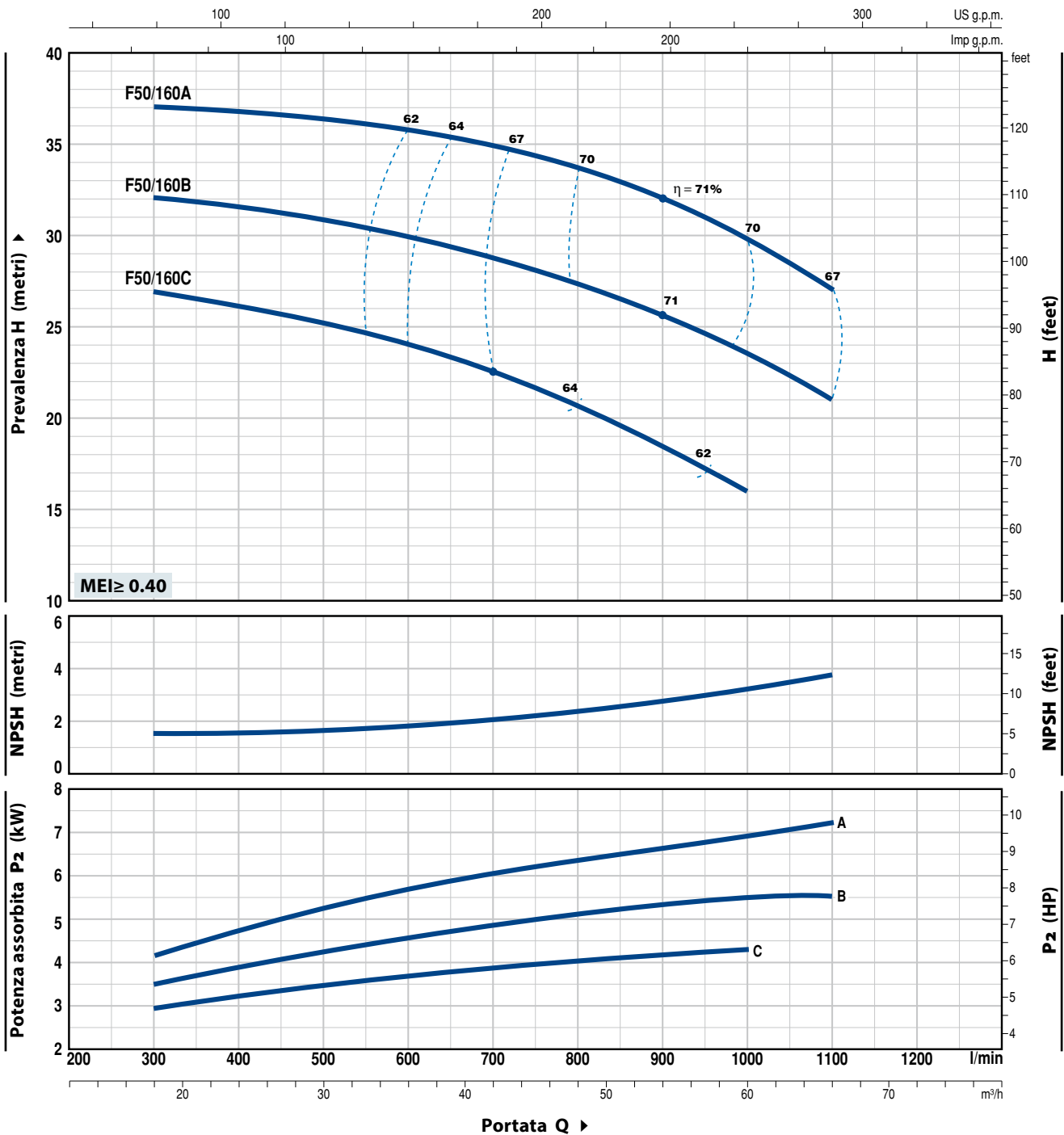

TIPO	POTENZA (P ₂)		Q	Flow Rate (Q)											
	kW	HP		0	18	24	30	36	42	48	54	60	66		
Trifase			l/min	0	300	400	500	600	700	800	900	1000	1100		
F 50/160C	4	5.5	H metri	27	27	26.5	25	24.5	23	20	18.5	16			
F 50/160B	5.5	7.5		33	32	31.7	31	30	29	27	26	24	21		
F 50/160A	7.5	10		38	37	36.8	36.5	36	34	33	32	30	27		

Q = Portata H = Prevalenza manometrica totale HS = Altezza di aspirazione

Tolleranza delle curve di prestazione secondo EN ISO 9906 Grado 3B.

F50/200

CURVE E DATI DI PRESTAZIONE

50 Hz n= 2900 rpm HS= 0 m

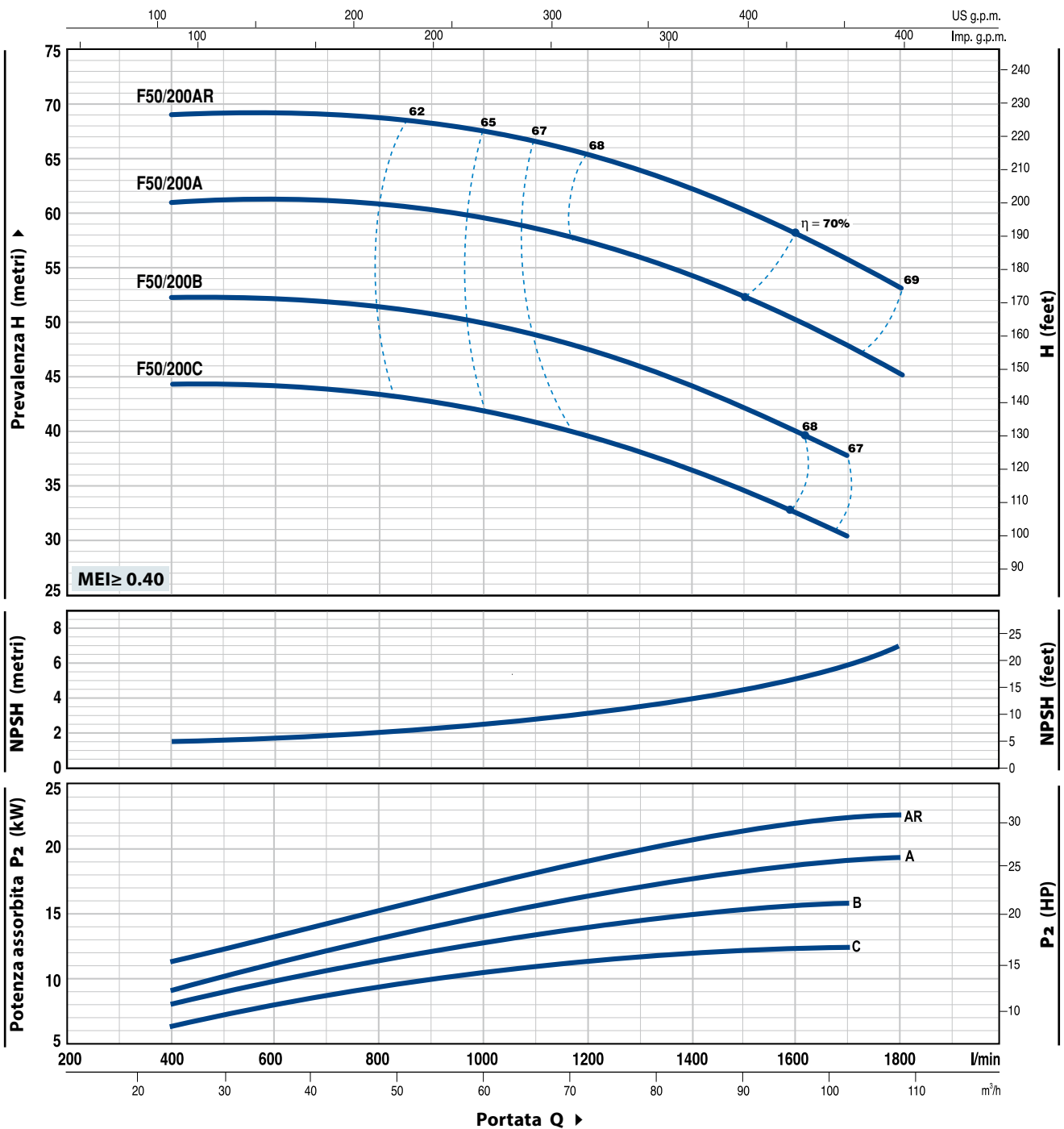

TIPO	POTENZA (P ₂)		Q	H metri										
	kW	HP		24	36	48	60	72	84	96	102	108		
Trifase			l/min	400	600	800	1000	1200	1400	1600	1700	1800		
F 50/200C	11	15		44	44	44	42	39	36	33	30			
F 50/200B	15	20		52	52	52	50	47	44	40	38			
F 50/200A	18.5	25		61	61	60.5	60	57	54	50	48	45		
F 50/200AR	22	30		69	69	68.5	68	65	62	58	56	53		

Q = Portata H = Prevalenza manometrica totale HS = Altezza di aspirazione

Tolleranza delle curve di prestazione secondo EN ISO 9906 Grado 3B.

CURVE E DATI DI PRESTAZIONE

50 Hz n= 2900 rpm HS= 0 m

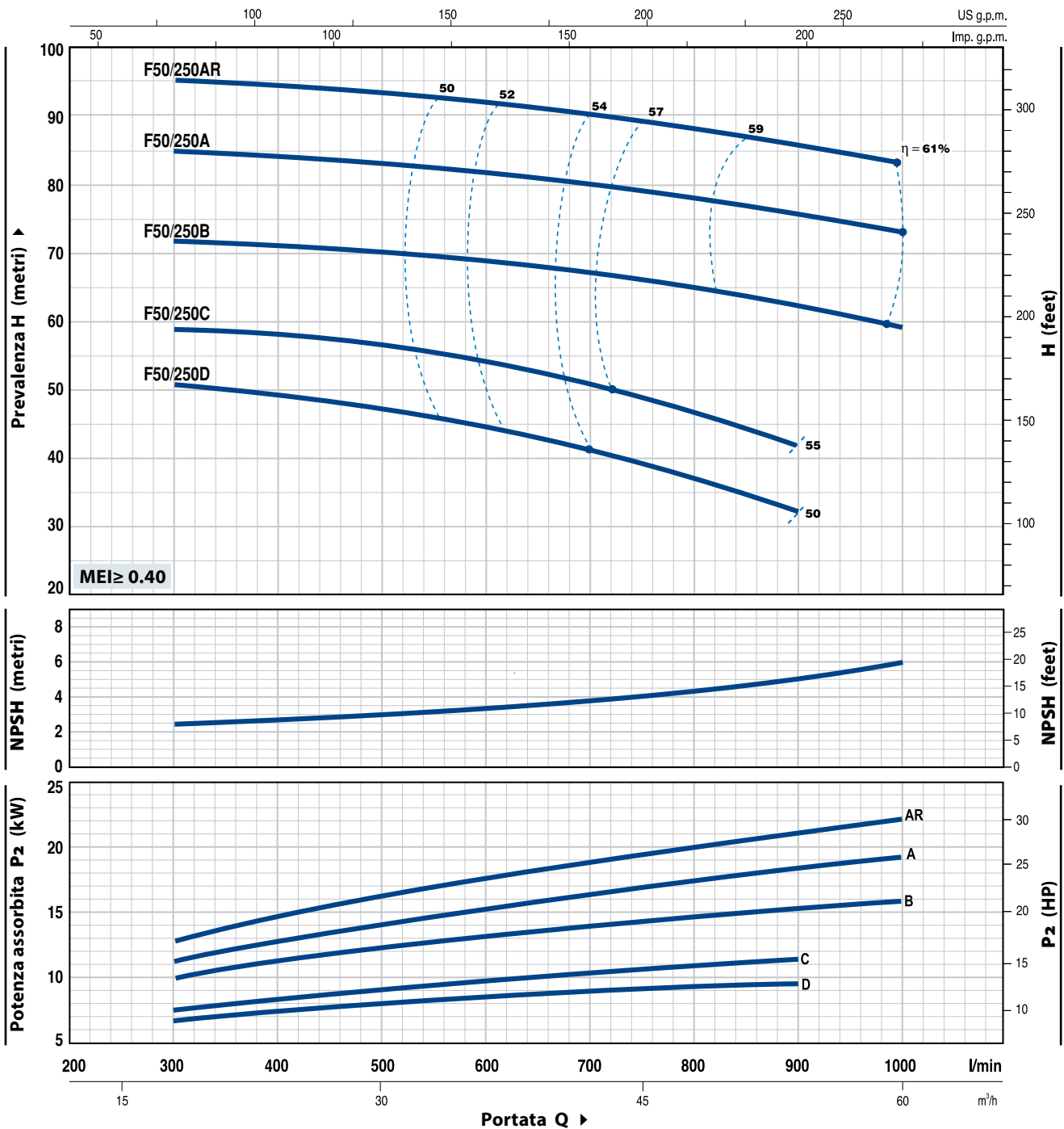

TIPO Trifase	POTENZA (P ₂)		Q m ³ /h l/min	Flow Rate (l/min)										
	kW	HP		0	18	24	30	36	42	48	54	60		
F 50/250D	9.2	12.5	H metri	51	51	49	47	44	41	37	32			
F 50/250C	11	15		59	59	58	57	54	51	47	42			
F 50/250B	15	20		72	72	71	70	69	67	65	62	59		
F 50/250A	18.5	25		85	85	84	83	82	80	78	76	73		
F 50/250AR	22	30		95	95	94	93	92	90	88	86	83		

Q = Portata H = Prevalenza manometrica totale HS = Altezza di aspirazione

Tolleranza delle curve di prestazione secondo EN ISO 9906 Grado 3B.

F65/125

CURVE E DATI DI PRESTAZIONE

50 Hz n= 2900 rpm HS= 0 m

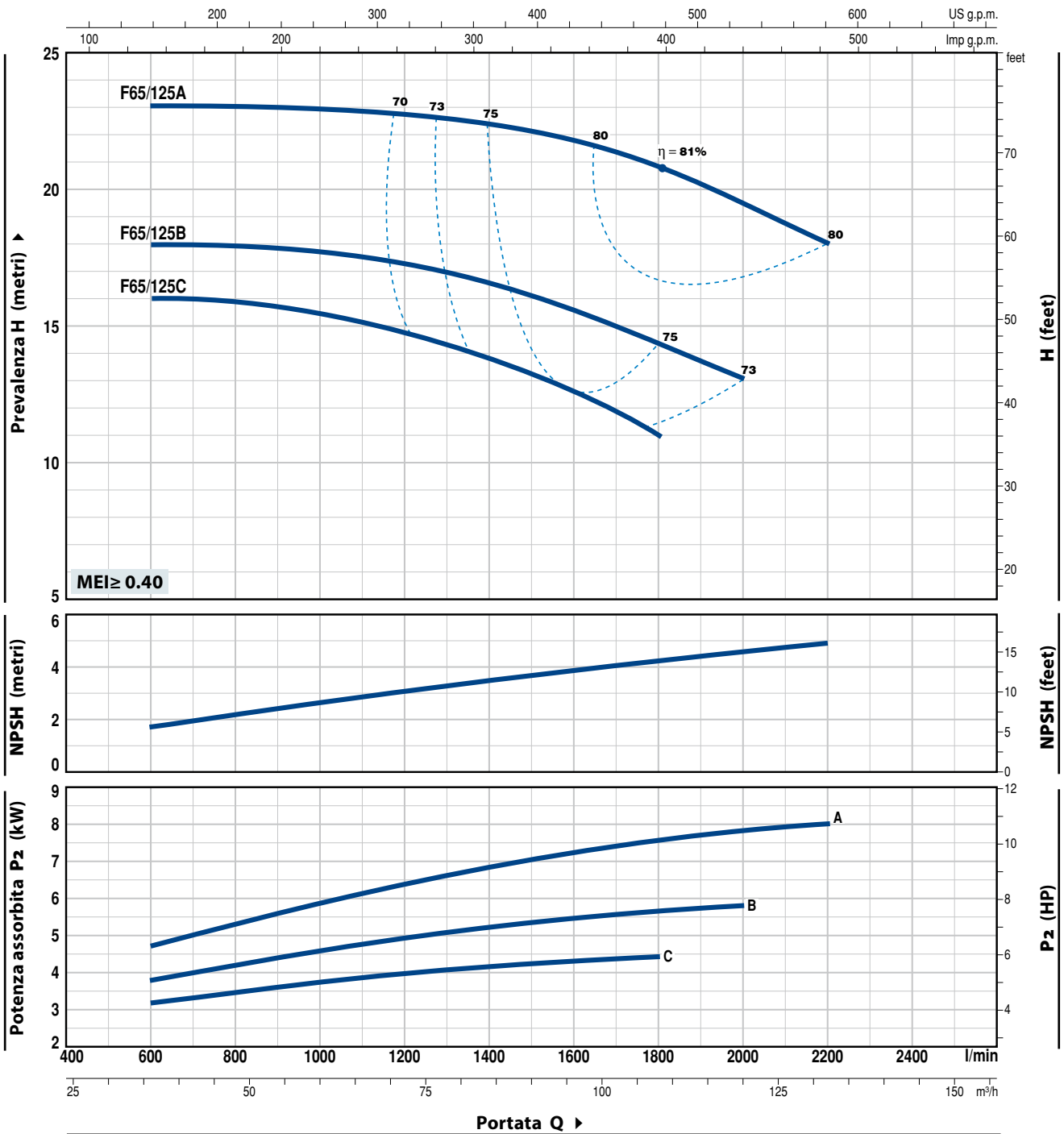

TIPO	POTENZA (P ₂)		Q	m ³ /h											
	kW	HP		0	36	48	60	72	84	96	108	120	132		
Trifase			l/min	0	600	800	1000	1200	1400	1600	1800	2000	2200		
F 65/125C	4	5.5	H metri	16	16	16	15.5	14.5	13.5	12.5	11				
F 65/125B	5.5	7.5		18	18	18	18	17	16.5	15.5	14.5	13			
F 65/125A	7.5	10		23	23	23	23	22.5	22.5	22	21	19.5	18		

Q = Portata H = Prevalenza manometrica totale HS = Altezza di aspirazione

Tolleranza delle curve di prestazione secondo EN ISO 9906 Grado 3B.

CURVE E DATI DI PRESTAZIONE

50 Hz n= 2900 rpm HS= 0 m

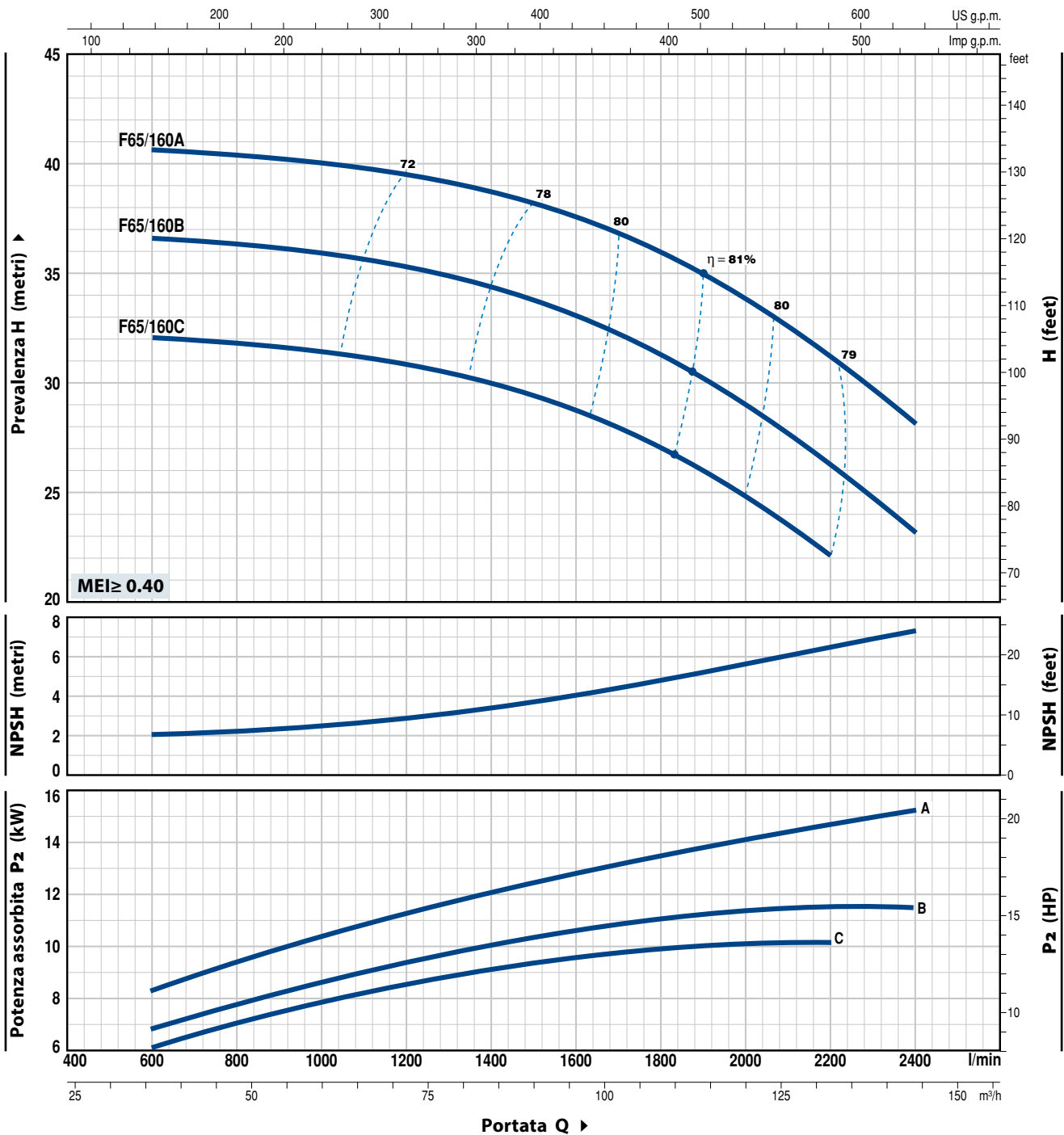

TIPO	POTENZA (P ₂)		Q	Flow Rate (Q)													
	kW	HP		0	36	48	60	72	84	96	108	120	132	144			
Trifase			l/min	0	600	800	1000	1200	1400	1600	1800	2000	2200	2400			
F 65/160C	9.2	12.5	H metri	32	32	32	32	32	30	29	27	25	22				
F 65/160B	11	15		37	36.5	36.5	36	35.5	34	33	31	29	26	23			
F 65/160A	15	20		41	40.5	40.5	40	39.5	39	37.5	36	34	31	28			

Q = Portata H = Prevalenza manometrica totale HS = Altezza di aspirazione

Tolleranza delle curve di prestazione secondo EN ISO 9906 Grado 3B.

F65/200

CURVE E DATI DI PRESTAZIONE

50 Hz n= 2900 rpm HS= 0 m

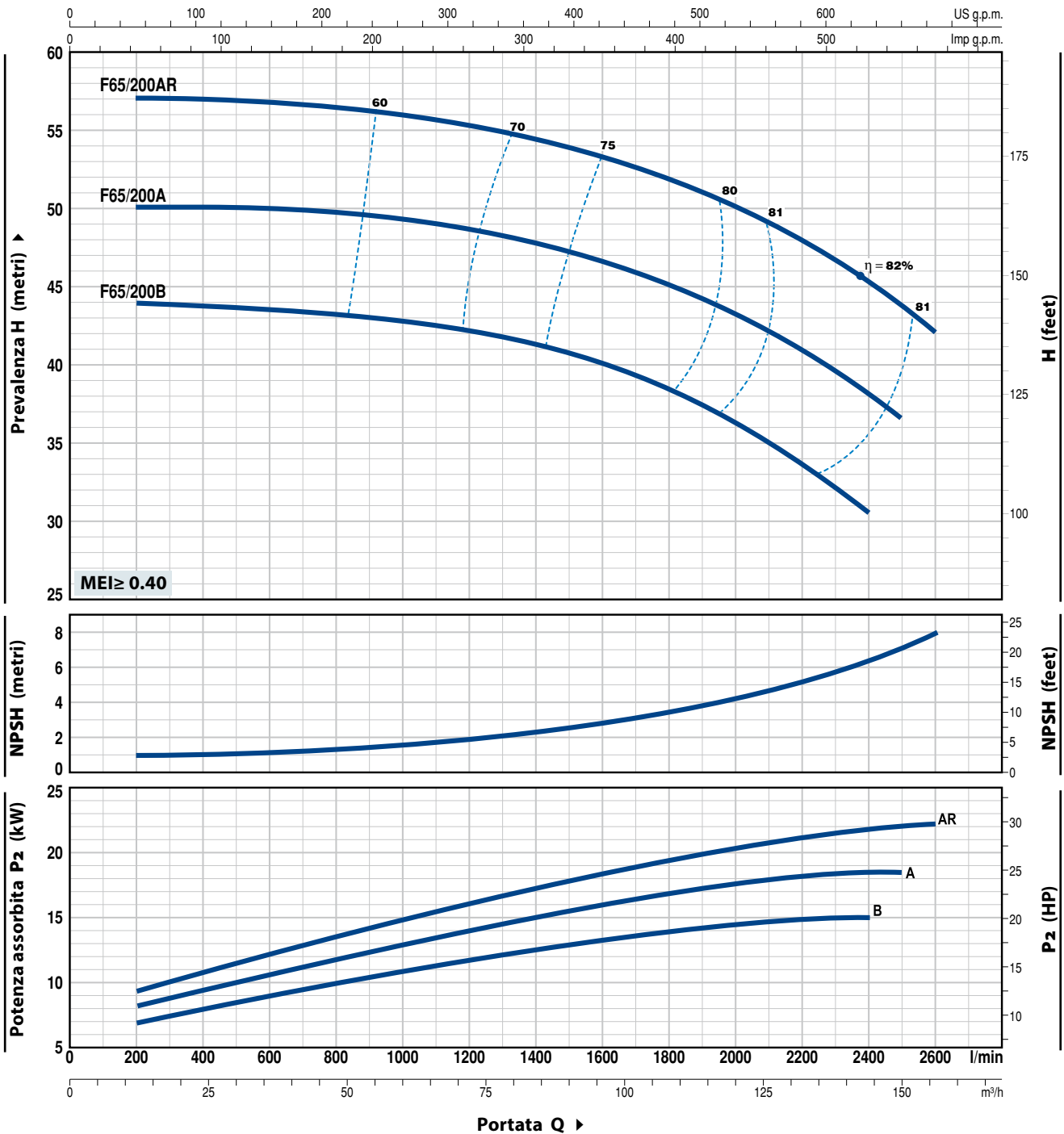

TIPO	POTENZA (P ₂)		Q	m ³ /h														
	kW	HP		12	36	48	60	72	84	96	108	120	132	144	150	156		
Trifase			l/min	200	600	800	1000	1200	1400	1600	1800	2000	2200	2400	2500	2600		
F 65/200B	15	20	H metri	44	43.5	43.3	43	42.5	41.5	40	38.5	36.5	34	30.5				
F 65/200A	18.5	25		50	50	50	49.5	49	48	46.5	45	43	41	38	36.5			
F 65/200AR	22	30		57	57	57	56	55.5	54.5	53.5	52	50	48	45.5	43.5	42		

Q = Portata H = Prevalenza manometrica totale HS = Altezza di aspirazione

Tolleranza delle curve di prestazione secondo EN ISO 9906 Grado 3B.

CURVE E DATI DI PRESTAZIONE

50 Hz n= 2900 rpm HS= 0 m

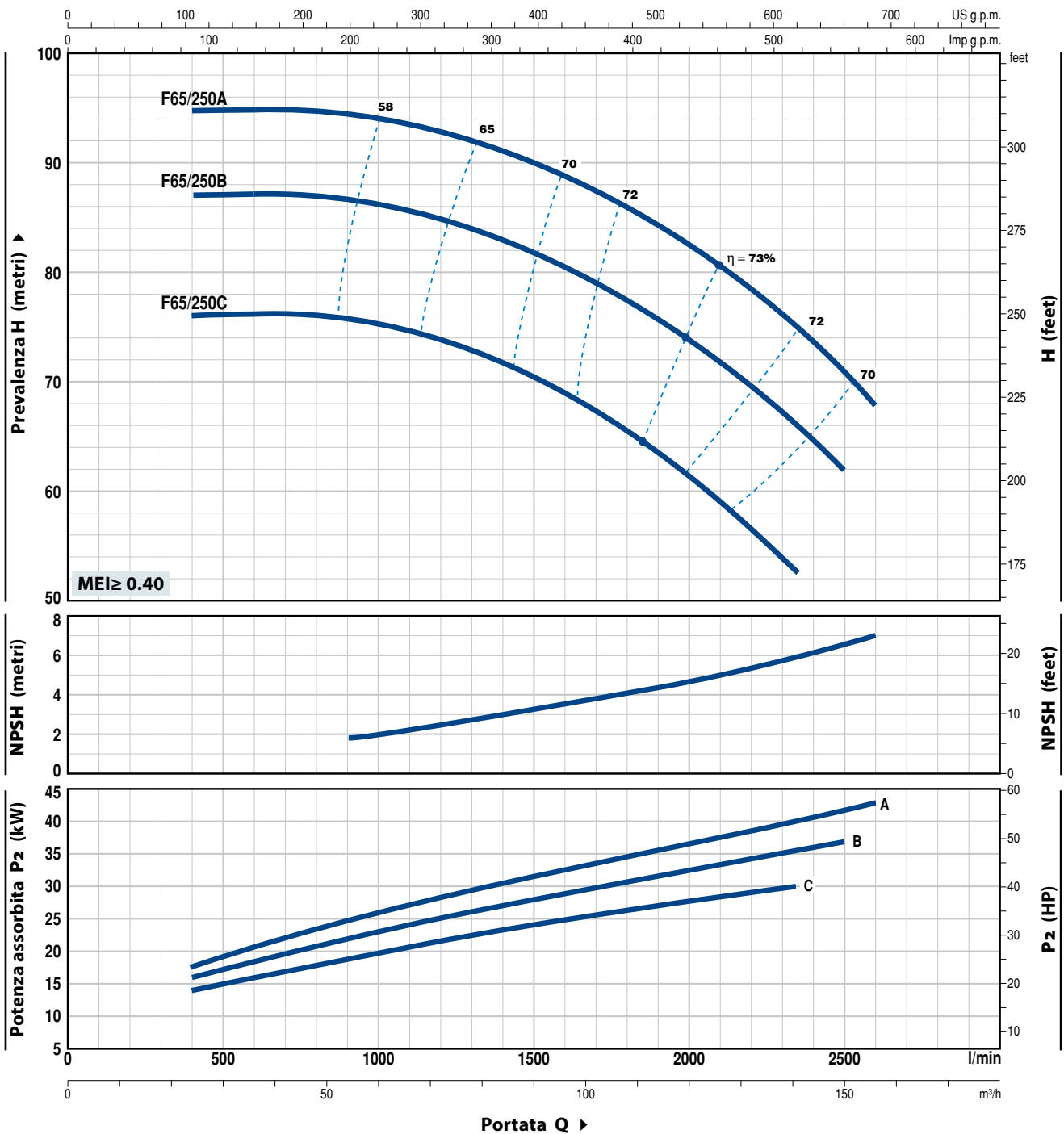

TIPO	POTENZA (P ₂)		Q	Flow Rate (Q)										
	kW	HP		m ³ /h	24	40	60	80	100	120	141	150	156	
Trifase			l/min	400	667	1000	1333	1667	2000	2350	2500	2600		
F 65/250C	30	40	H metri	76	76	75.5	72.5	68	61.5	53				
F 65/250B	37	50		87	87	86	84	80	74	66.5	62			
F 65/250A	45	60		95	95	94	92	88	82.5	75	71	68		

Q = Portata H = Prevalenza manometrica totale HS = Altezza di aspirazione

Tolleranza delle curve di prestazione secondo EN ISO 9906 Grado 3B.

F80/160

CURVE E DATI DI PRESTAZIONE

50 Hz n= 2900 rpm HS= 0 m

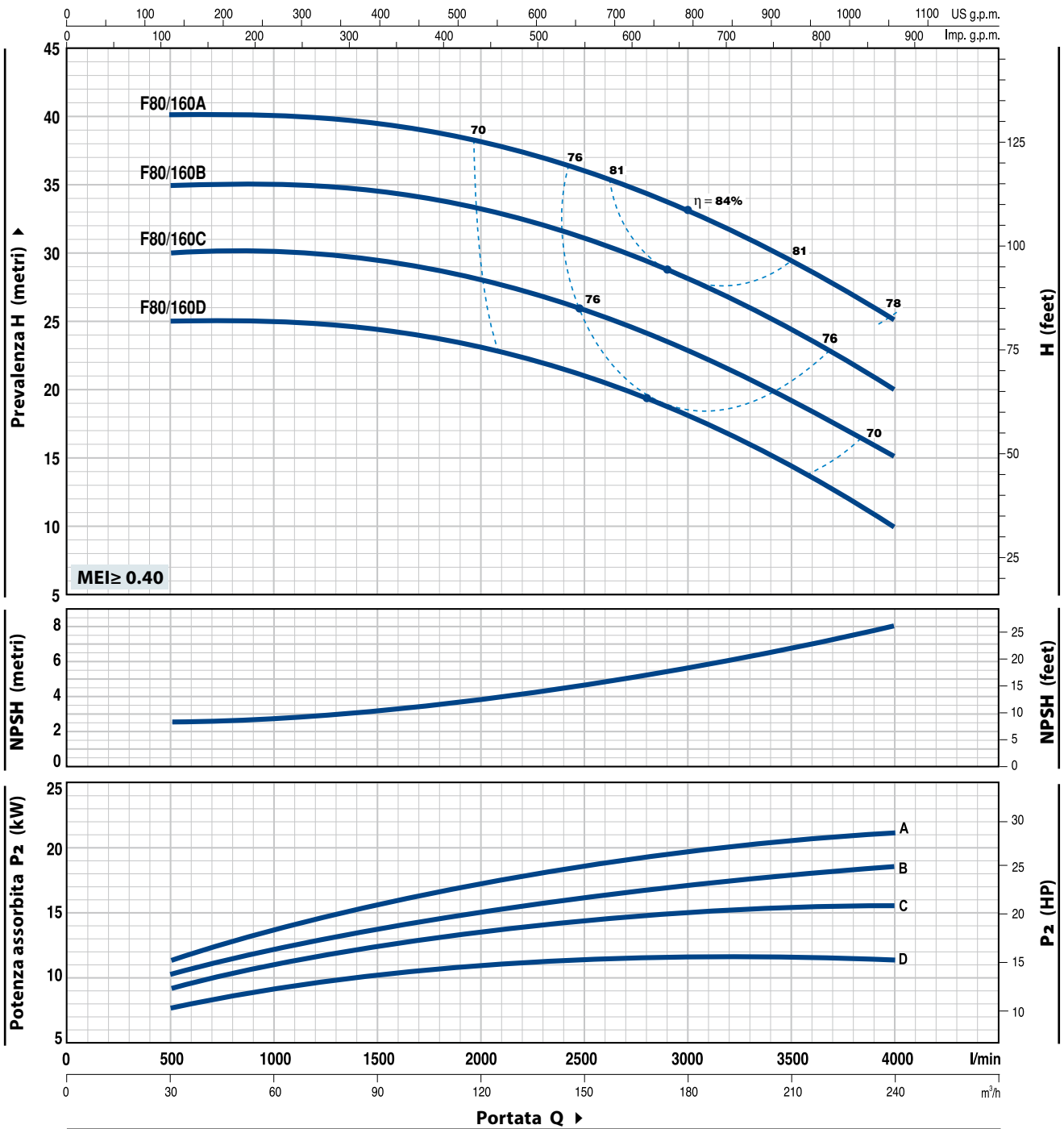

TIPO	POTENZA (P ₂)		Q	H (metri)											
	kW	HP		0	30	60	90	120	150	180	210	240			
Trifase			l/min	0	500	1000	1500	2000	2500	3000	3500	4000			
F 80/160D	11	15		25	25	25	24.5	23.5	21	18	14.5	10			
F 80/160C	15	20		30	30	30	29.5	28.5	26	23	19.5	15			
F 80/160B	18.5	25		35	35	35	34.5	33.5	31	28.5	24.5	20			
F 80/160A	22	30		40	40	40	39.5	38.5	36	33	29.5	25			

Q = Portata H = Prevalenza manometrica totale HS = Altezza di aspirazione

Tolleranza delle curve di prestazione secondo EN ISO 9906 Grado 3B.

CURVE E DATI DI PRESTAZIONE

50 Hz n= 2900 rpm HS= 0 m

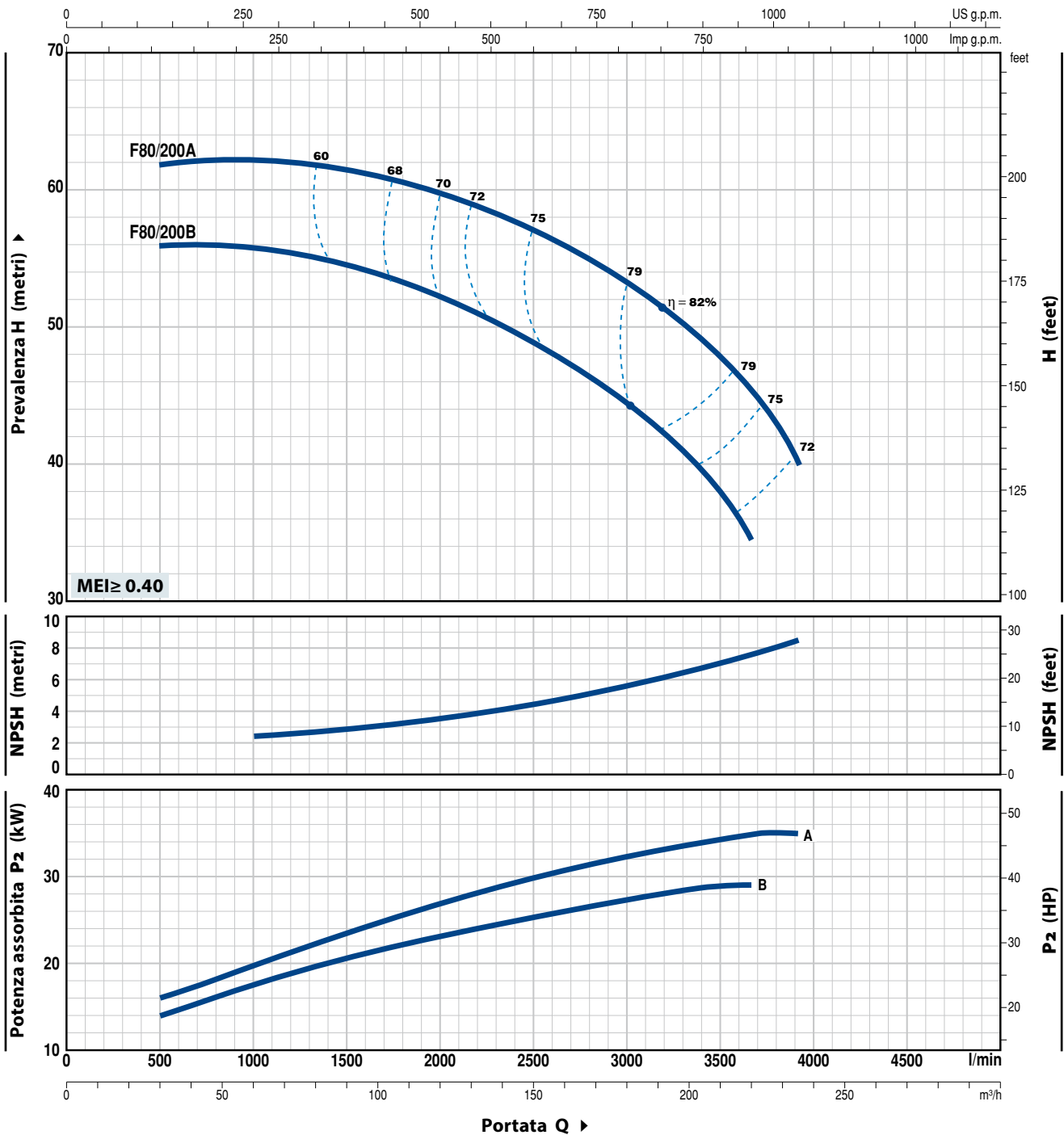

TIPO	POTENZA (P ₂)		Q	Flow Rate (Q)						
	kW	HP		m ³ /h	l/min	l/min	l/min	l/min	l/min	l/min
Trifase				30	50	100	150	200	219	234
				500	833	1667	2500	3333	3650	3900
F 80/200B	30	40	H metri	56	56	54	49	41	34.5	
F 80/200A	37	50		62	62	61	57	50	45.5	40

Q = Portata H = Prevalenza manometrica totale HS = Altezza di aspirazione

Tolleranza delle curve di prestazione secondo EN ISO 9906 Grado 3B.

F80/250

CURVE E DATI DI PRESTAZIONE

50 Hz n= 2900 rpm HS= 0 m

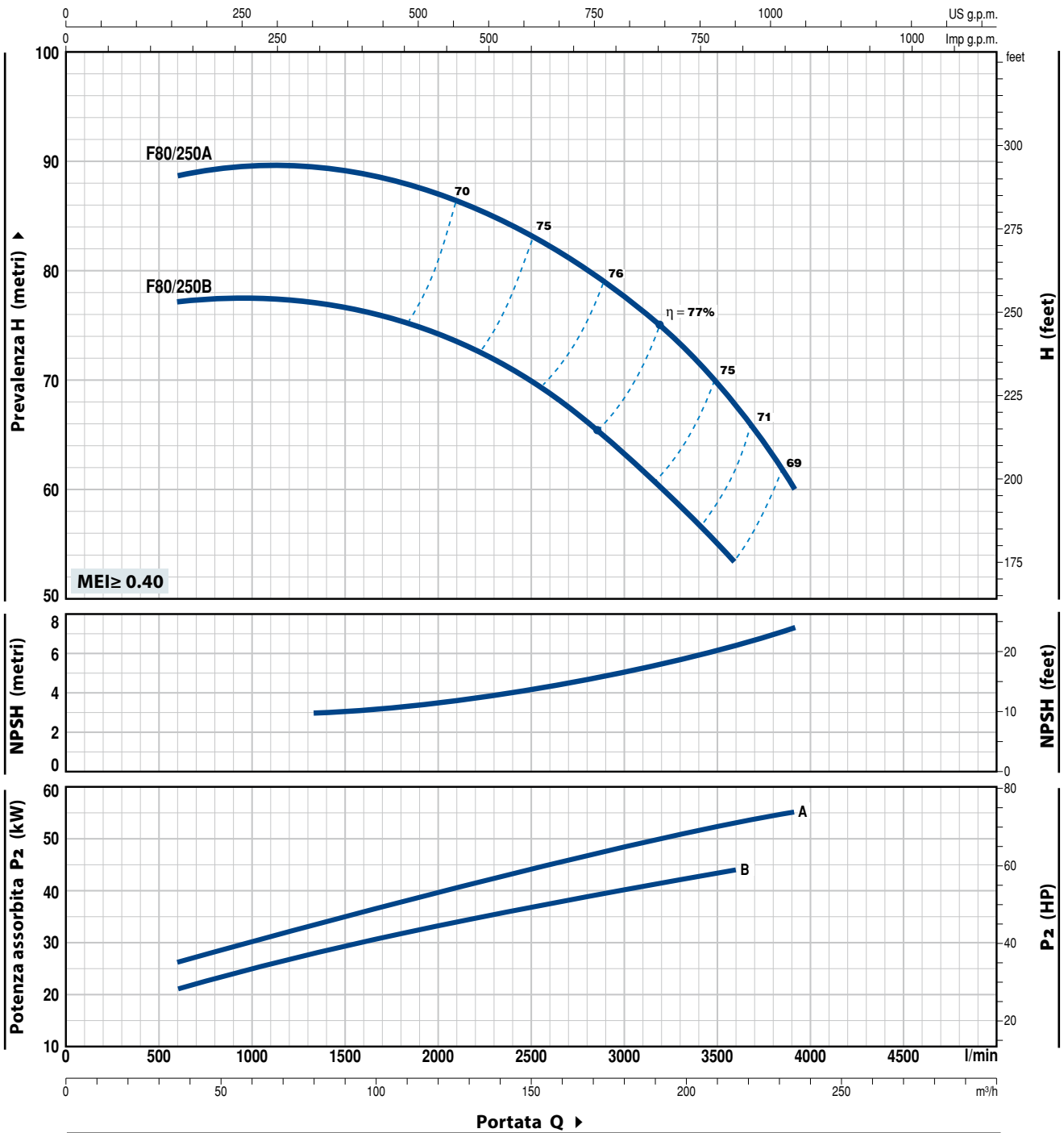

TIPO	POTENZA (P ₂)		Q	Flow Rate						
	kW	HP		m ³ /h	l/min	m ³ /h	l/min	m ³ /h	l/min	
Trifase				600	833	1667	2500	3333	3600	3900
F 80/250B	45	60	H metri	77	77.5	76	70.5	58.5	54	
F 80/250A	55	75	H metri	88.5	89.5	89	83	72	68	60

Q = Portata H = Prevalenza manometrica totale HS = Altezza di aspirazione

Tolleranza delle curve di prestazione secondo EN ISO 9906 Grado 3B.

CURVE E DATI DI PRESTAZIONE

50 Hz n= 2900 rpm HS= 0 m

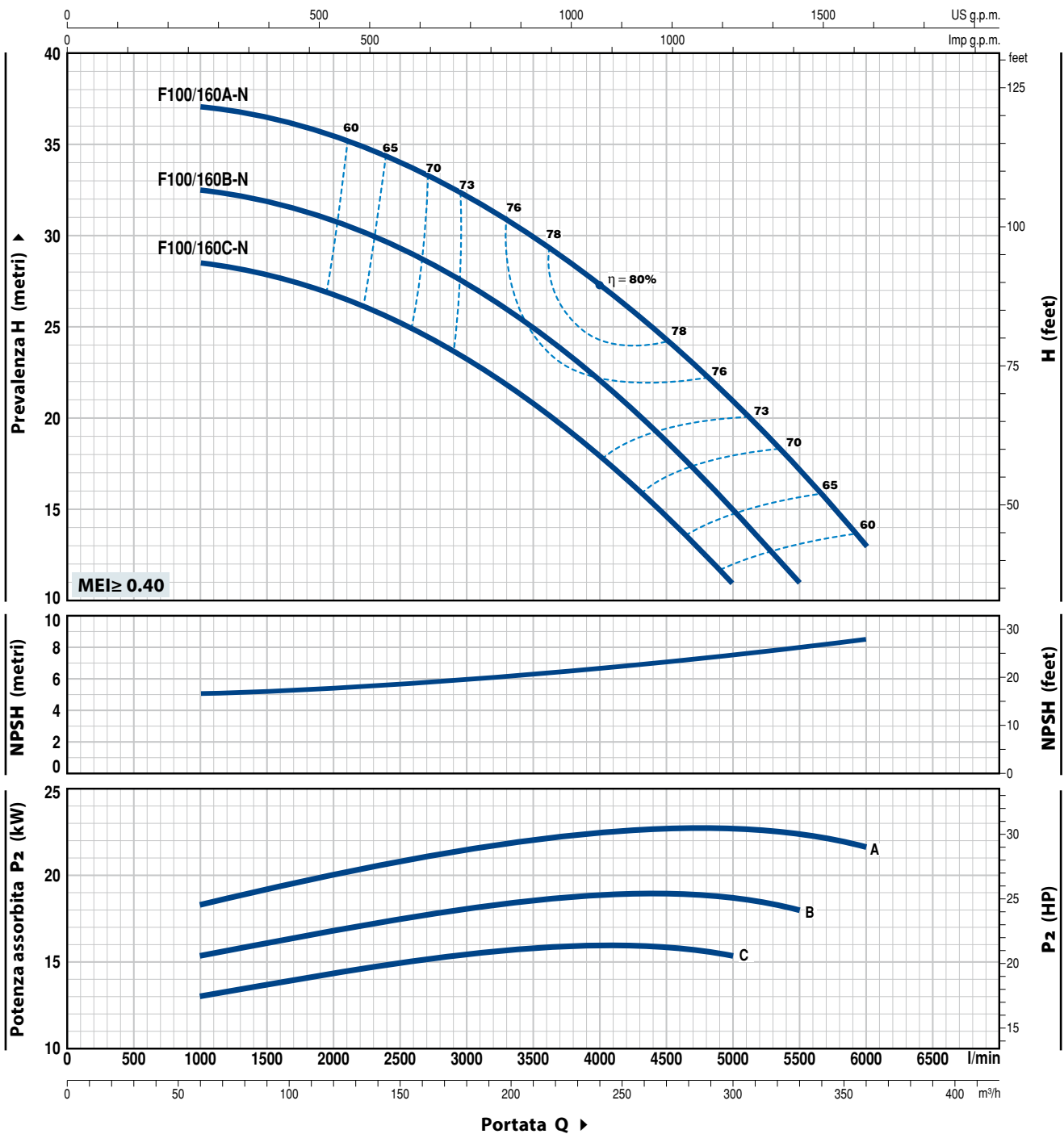

TIPO	POTENZA (P ₂)		Q	60	120	180	240	270	300	330	360	
	kW	HP		m ³ /h	l/min	1000	2000	3000	4000	4500	5000	5500
F 100/160C-N	15	20	H metri	28.5	26.5	23	18	14.5	11			
F 100/160B-N	18.5	25		32.5	30.5	27	22	18.5	15	11		
F 100/160A-N	22	30		37	35.5	32	27	24	20.5	17	13	

Q = Portata H = Prevalenza manometrica totale HS = Altezza di aspirazione

Tolleranza delle curve di prestazione secondo EN ISO 9906 Grado 3B.

F100/200

CURVE E DATI DI PRESTAZIONE

50 Hz n= 2900 rpm HS= 0 m

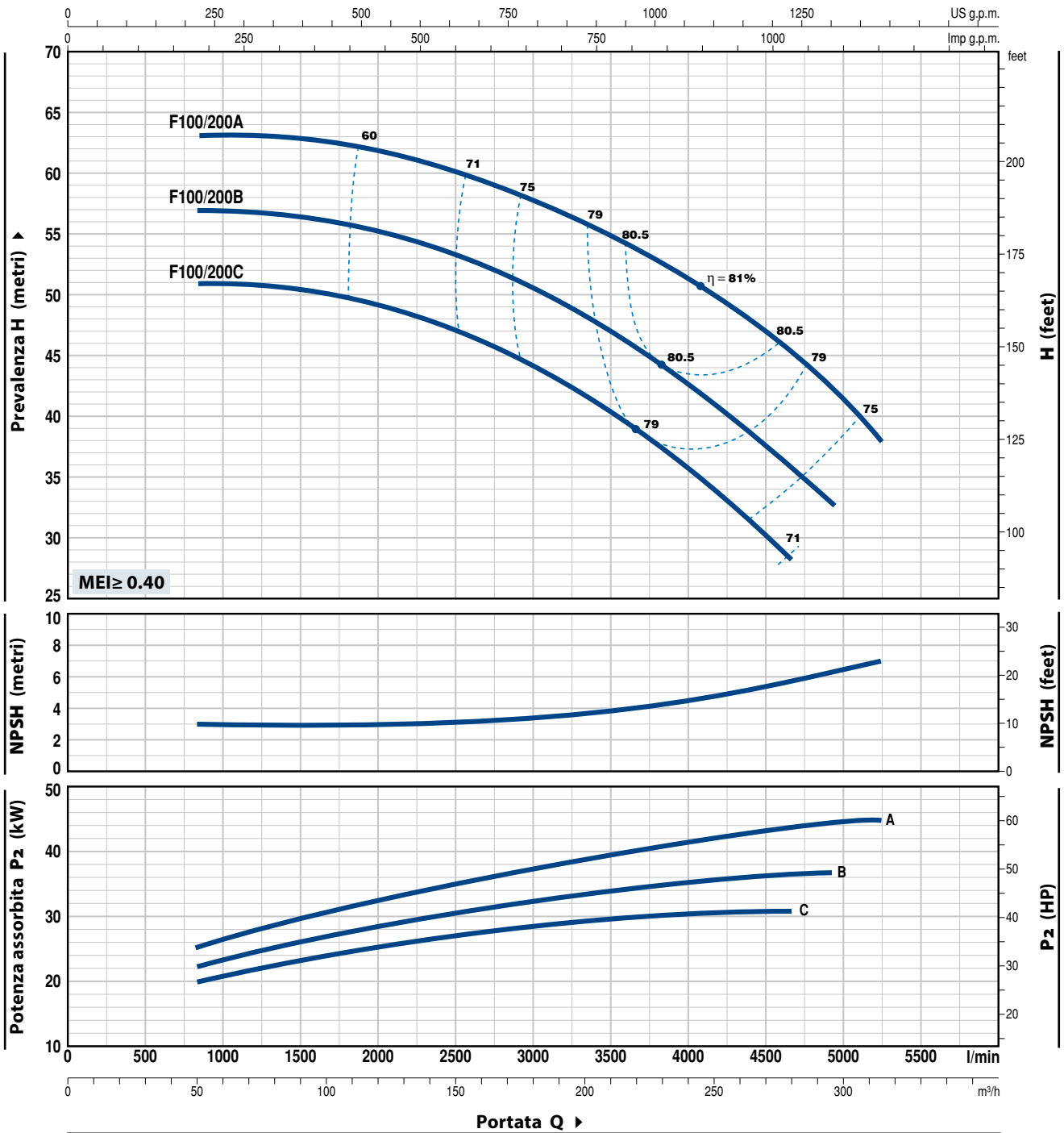

TIPO	POTENZA (P ₂)		Q	H											
	kW	HP		m ³ /h	0	50	100	150	200	250	279	294	300	315	
Trifase			l/min	0	833	1667	2500	3333	4167	4650	4900	5000	5250		
F 100/200C	30	40	H metri	51	51	50	47	41.5	34	28					
F 100/200B	37	50		57	57	56	53	48	41	36	33				
F 100/200A	45	60		63	63	62.5	60	56	50	45	42.5	41.5	38		

Q = Portata H = Prevalenza manometrica totale HS = Altezza di aspirazione

Tolleranza delle curve di prestazione secondo EN ISO 9906 Grado 3B.

CURVE E DATI DI PRESTAZIONE

50 Hz n= 2900 rpm HS= 0 m

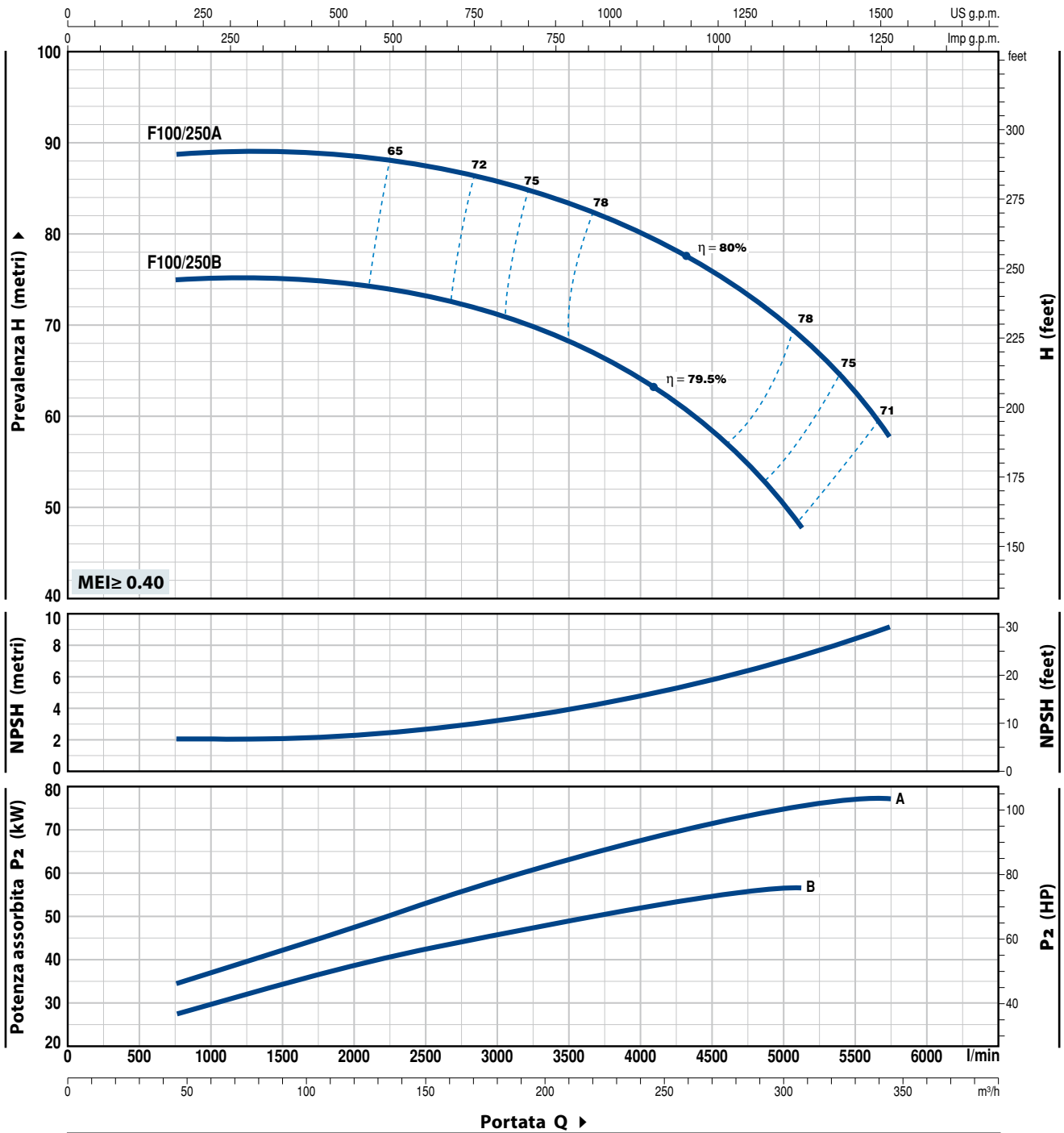

TIPO	POTENZA (P ₂)		Q	Flow Rates										
	kW	HP		m ³ /h	48	96	150	180	210	240	300	309	345	
Trifase			l/min	800	1600	2500	3000	3500	4000	5000	5150	5750		
F 100/250B	55	75	H metri	75	75	74	71.5	69	64.5	51	48			
F 100/250A	75	100		89	89	88.5	87	84	80.5	70.5	69	58		

Q = Portata H = Prevalenza manometrica totale HS = Altezza di aspirazione

Tolleranza delle curve di prestazione secondo EN ISO 9906 Grado 3B.

POS. COMPONENTE CARATTERISTICHE COSTRUTTIVE

1	CORPO POMPA	Ghisa, provvisto di bocche di aspirazione e di mandata flangiate				
2a	COPERCHIO	Ghisa	per F32/160, F32/200, F40/125, F40/160, F40/200, F50/125, F50/160, F65/125			
2b	LANTERNA	Ghisa	per F32/250, F40/250, F50/200, F50/250, F65/160, F65/200, F65/250, F80/160, F80/200, F80/250, F100/160, F100/200, F100/250			
3	GIRANTE	Ottone	per F32/160, F32/200, F40/125, F40/160, F40/200, F50/125, F50/160			
		Ghisa	per F32/250, F40/250, F50/200, F50/250, F65/125, F65/160, F65/200, F65/250, F80/160, F80/200, F80/250, F100/160, F100/200, F100/250			
4	ALBERO MOTORE	Acciaio inox EN 10088-3 - 1.4104				
5	TENUTA MECCANICA	Elettropompa	Tenuta	Albero	Materiali	
		Tipo	Tipo	Diametro	Anello fisso	Anello rotante Elastomero
		F32/160, F40/125, F40/160, 50/125	FN-20	Ø 20 mm	Grafite	Ceramica NBR
		F32/200, F40/200, F50/160, F65/125	FN-24	Ø 24 mm	Grafite	Ceramica NBR
		F50/200, F65/160, F65/200, F80/160, F100/160	FN-32 NU	Ø 32 mm	Grafite	Ceramica NBR
		F32/250, F40/250, F50/250	FN-38	Ø 38 mm	Grafite	Ceramica NBR
		F65/250, F80/200, F80/250B, F100/200	FN-40 NU	Ø 40 mm	Grafite	Ceramica NBR
		F80/250A, F100/250	FH-45 NU	Ø 45 mm	Grafite	Ceramica NBR
6	CUSCINETTI	Elettropompa	Tipo	Elettropompa	Tipo	
		F32/160C F40/160C	6206 ZZ-C3 / 6204 ZZ	F32/250 F50/200	6310 ZZ-C3 / 6308 ZZ-C3	
		F32/160B F50/125C		F40/250 F65/160		
		F40/125		F50/250 F80/160		
		Fm32/160B F32/160A	6206 ZZ-C3 / 6205 ZZ	F65/200 F100/160	6312 ZZ-C3 / 6212 ZZ-C3	
		Fm40/160C F40/160B		F65/250 F80/200		
		Fm50/125C F50/125B		F80/250B F100/200		
		F40/160A	6306 ZZ-C3 / 6206 ZZ-C3	F80/250A	6314 ZZ-C3 / 6313 ZZ-C3	
		F50/125A		F100/250		
		F32/200 F40/200	6307 ZZ-C3 / 6206 ZZ-C3			
		F50/160 F65/125				
7	CONDENSATORE	Elettropompa	Capacità			
		Monofase	(230 V o 240 V)			
		Fm32/160C	45 µF - 450 VL			
		Fm32/160B	70 µF - 450 VL			
		Fm40/125C	31.5 µF - 450 VL			
		Fm40/125B	45 µF - 450 VL			
		Fm40/160C	70 µF - 450 VL			
		Fm50/125C	70 µF - 450 VL			
8	MOTORE ELETTRICO	Fm: monofase 230 V - 50 Hz con salvamotore termico incorporato nell'avvolgimento (fino a 1.5 kW) F: trifase 230/400 V - 50 Hz fino a 4 kW 400/690 V - 50 Hz da 5.5 a 75 kW ► Le elettropompe trifase sono equipaggiate con motori ad alto rendimento in classe IE2 fino a P₂=1.1 kW e in classe IE3 da P₂=1.5 kW (IEC 60034-30) - Isolamento: classe F - Protezione: IP 55				

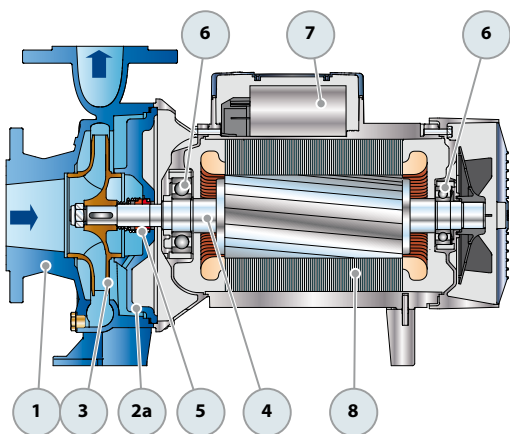

Versione monofase

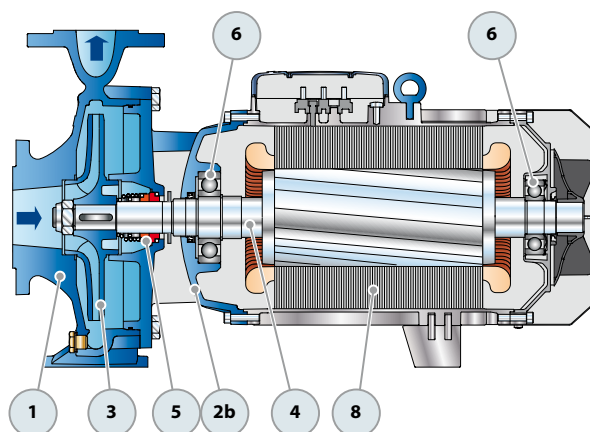

Versione trifase

ASSORBIMENTI

TIPO	TENSIONE	
	230 V	240 V
Monofase		
Fm 32/160C	11.0 A	10.0 A
Fm 32/160B	15.0 A	13.8 A
Fm 40/125C	8.6 A	7.8 A
Fm 40/125B	15.0 A	13.8 A
Fm 40/160C	15.0 A	13.8 A
Fm 50/125C	15.0 A	13.8 A

TIPO	TENSIONE		
	230÷240 V	400÷415 V	690÷720 V
Trifase			
F 32/160C	7.5 A	4.3 A	2.5 A
F 32/160B	10.0 A	5.8 A	3.4 A
F 32/160A	12.0 A	7.3 A	4.2 A
F 32/200C	17.9 A	10.3 A	5.9 A
F 32/200B	–	11.7 A	6.7 A
F 32/200A	–	14.9 A	8.6 A
F 32/200BH	12.6 A	7.3 A	4.2 A
F 32/200AH	15.4 A	8.9 A	5.1 A
F 32/250C	–	17.2 A	9.9 A
F 32/250B	–	21.0 A	12.0 A
F 32/250A	–	27.0 A	15.6 A
F 40/125C	5.7 A	3.3 A	1.9 A
F 40/125B	7.5 A	4.3 A	2.5 A
F 40/125A	10.0 A	5.8 A	3.4 A
F 40/160C	9.9 A	5.7 A	3.3 A
F 40/160B	12.0 A	6.9 A	4.0 A
F 40/160A	17.2 A	9.9 A	5.7 A
F 40/200B	–	12.6 A	7.3 A
F 40/200A	–	15.6 A	9.0 A
F 40/250C	–	21.0 A	12.1 A
F 40/250B	–	23.5 A	13.6 A
F 40/250A	–	30.5 A	17.6 A
F 50/125C	9.4 A	5.4 A	3.1 A
F 50/125B	12.0 A	6.9 A	4.0 A
F 50/125A	16.3 A	9.4 A	5.4 A
F 50/160C	15.8 A	9.1 A	5.3 A
F 50/160B	–	12.3 A	7.1 A
F 50/160A	–	15.5 A	8.9 A
F 50/200C	–	23.0 A	13.3 A
F 50/200B	–	29.5 A	17.0 A
F 50/200A	–	34.5 A	20.0 A
F 50/200AR	–	41.5 A	24.0 A

TIPO	TENSIONE		
	230÷240 V	400÷415 V	690÷720 V
Trifase			
F 50/250D	–	17.2 A	9.9 A
F 50/250C	–	21.0 A	12.0 A
F 50/250B	–	27.0 A	15.6 A
F 50/250A	–	34.0 A	19.6 A
F 50/250AR	–	41.0 A	24.0 A
F 65/125C	17.5 A	10.0 A	5.8 A
F 65/125B	–	12.0 A	7.0 A
F 65/125A	–	16.5 A	9.5 A
F 65/160C	–	19.0 A	11.0 A
F 65/160B	–	23.0 A	13.5 A
F 65/160A	–	27.5 A	16.0 A
F 65/200B	–	31.0 A	18.0 A
F 65/200A	–	34.0 A	19.5 A
F 65/200AR	–	41.0 A	23.7 A
F 65/250C	–	53.0 A	31.0 A
F 65/250B	–	65.0 A	38.0 A
F 65/250A	–	79.0 A	46.0 A
F 80/160D	–	22.0 A	13.0 A
F 80/160C	–	29.0 A	17.0 A
F 80/160B	–	34.5 A	20.0 A
F 80/160A	–	39.0 A	22.5 A
F 80/200B	–	53.0 A	31.0 A
F 80/200A	–	65.0 A	38.0 A
F 80/250B	–	79.0 A	46.0 A
F 80/250A	–	98.0 A	57.0 A
F 100/160C-N	–	31.0 A	18.0 A
F 100/160B-N	–	36.0 A	21.0 A
F 100/160A-N	–	42.0 A	24.0 A
F 100/200C	–	53.0 A	31.0 A
F 100/200B	–	65.0 A	38.0 A
F 100/200A	–	79.0 A	46.0 A
F 100/250B	–	98.0 A	57.0 A
F 100/250A	–	126.0 A	73.0 A

DIMENSIONI E PESI

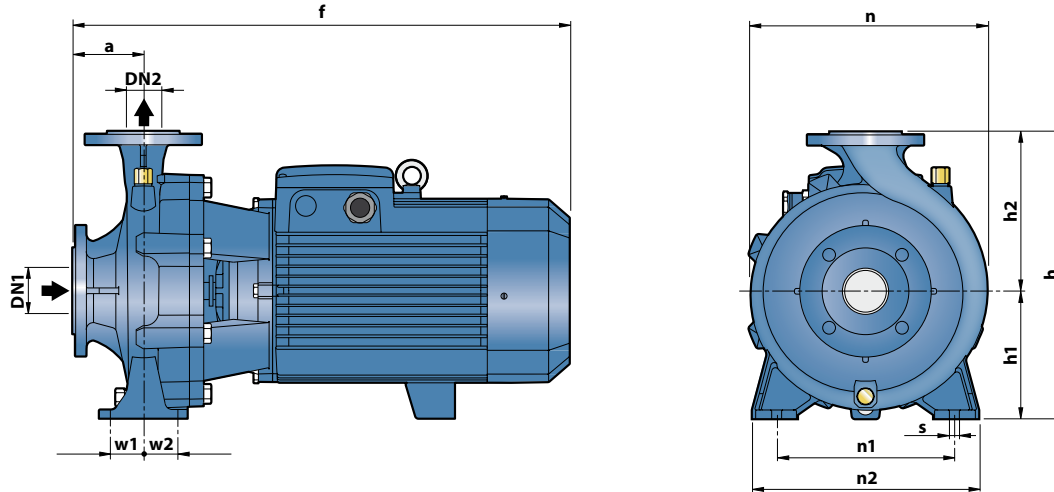

TIPO		DIMENSIONI mm													kg													
Monofase	Trifase	DN1	DN2	a	f	h	h1	h2	n	n1	n2	w1	w2	s	1~	3~												
Fm 32/160C	F 32/160C	50	32	80	412	340	160	180	270	190	240	35	35	14	32.7	32.1												
Fm 32/160B	F 32/160B				448/412										292	132	160	242	37.5	33.4								
-	F 32/160A				448										-	-	-	-	-	-								
-	F 32/200C				469										-	-	-	-	-	-								
-	F 32/200B				515										-	-	-	-	-	-								
-	F 32/200A			469	-	-	-	-	-	-																		
-	F 32/200BH			-	-	-	-	-	-	-	-	-	-		-	-	-	-										
-	F 32/200AH			-	-	-	-	-	-	-	-	-	-		-	-	-	-										
-	F 32/250C			-	-	100	606	405	180	225	330	250	320		47.5	47.5	-	100.0										
-	F 32/250B			-	-	701	-	-	-	-	-	-	-		-	-	-	102.0										
-	F 32/250A	-	-	-	-	-	-	-	-	-	-	-	-	-	119.8													
Fm 40/125C	F 40/125C	65	40	80	421	340	160	180	275	212	265	35	35	14	31.5	29.5												
Fm 40/125B	F 40/125B				448/412										292	132	160	240	190	240	35	35	33.0	31.5				
-	F 40/125A				448										-	-	-	-	-	-	-	-	-	-	-	-	33.0	
Fm 40/160C	F 40/160C				465										-	-	-	-	-	-	-	-	-	-	-	-	37.6	33.5
-	F 40/160B				535										-	-	-	-	-	-	-	-	-	-	-	-	-	37.5
-	F 40/160A			465	-	-	-	-	-	-	-	-	-		-	-	-	-	43.6									
-	F 40/200B			535	-	-	-	-	-	-	-	-	-		-	-	-	-	54.0									
-	F 40/200A			606	-	-	-	-	-	-	-	-	-		-	-	-	-	60.0									
-	F 40/250C			606	405	180	225	328	250	320	47.5	47.5	-		-	-	-	100.0										
-	F 40/250B			701	-	-	-	-	-	-	-	-	-		-	-	-	102.0										
-	F 40/250A	701	-	-	-	-	-	-	-	-	-	-	-	-	119.8													
Fm 50/125C	F 50/125C	65	50	100	465/431	360	160	180	269	212	265	35	35	14	37.3	33.2												
-	F 50/125B				465										292	132	160	242	190	240	-	-	-	-	-	-	37.2	
-	F 50/125A				484										-	-	-	-	-	-	-	-	-	-	-	-	-	43.3
-	F 50/160C				489										-	-	-	-	-	-	-	-	-	-	-	-	-	48.0
-	F 50/160B				535										340	180	269	212	265	35	35	-	-	-	-	-	-	52.5
-	F 50/160A			616	-	-	-	-	-	-	-	-	-		-	-	-	-	56.4									
-	F 50/200C			616	160	180	269	212	265	35	35	-	-		-	-	-	-	97.7									
-	F 50/200B			711	360	200	316	212	265	47.5	47.5	-	-		-	-	-	-	114.0									
-	F 50/200A			711	-	-	-	-	-	-	-	-	-		-	-	-	-	126.5									
-	F 50/200AR			743	-	-	-	-	-	-	-	-	-		-	-	-	-	140.3									
-	F 50/250D	606	-	-	-	-	-	-	-	-	-	-	-	-	-	101.3												
-	F 50/250C	606	405	180	225	337	250	320	-	-	-	-	-	-	-	103.3												
-	F 50/250B	701	-	-	-	-	-	-	-	-	-	-	-	-	-	120.4												
-	F 50/250A	701	-	-	-	-	-	-	-	-	-	-	-	-	-	134.3												
-	F 50/250AR	733	-	-	-	-	-	-	-	-	-	-	-	-	-	147.4												
-	F 65/125C	511	340	180	291	212	280	47.5	47.5	-	-	-	-	-	-	53.5												
-	F 65/125B	557	160	180	291	212	280	47.5	47.5	-	-	-	-	-	-	56.8												
-	F 65/125A	557	-	-	-	-	-	-	-	-	-	-	-	-	-	63.3												
-	F 65/160C	621	360	200	300	212	280	47.5	47.5	-	-	-	-	-	-	98.3												
-	F 65/160B	621	-	-	-	-	-	-	-	-	-	-	-	-	-	99.3												
-	F 65/160A	716	-	-	-	-	-	-	-	-	-	-	-	-	-	114.3												
-	F 65/200B	716	-	-	-	-	-	-	-	-	-	-	-	-	-	120.3												
-	F 65/200A	719	-	-	-	-	-	-	340	-	-	-	-	-	-	132.9												
-	F 65/200AR	751	-	-	-	-	-	-	340	-	-	-	-	-	-	144.4												
-	F 80/160D	652	405	180	225	250	320	-	-	-	-	-	-	-	-	103.8												
-	F 80/160C	747	-	-	-	-	-	-	330	-	-	-	-	-	-	115.6												
-	F 80/160B	747	-	-	-	-	-	-	330	-	-	-	-	-	-	133.1												
-	F 80/160A	779	-	-	-	-	-	-	330	-	-	-	-	-	-	144.6												
-	F 100/160C-N	758	480	200	280	362	280	360	60	60	18	-	-	-	-	126.3												
-	F 100/160B-N	790	-	-	-	-	-	-	362	280	360	60	60	18	-	136.3												
-	F 100/160A-N	790	-	-	-	-	-	-	362	280	360	60	60	18	-	151.3												

DIMENSIONI E PESI

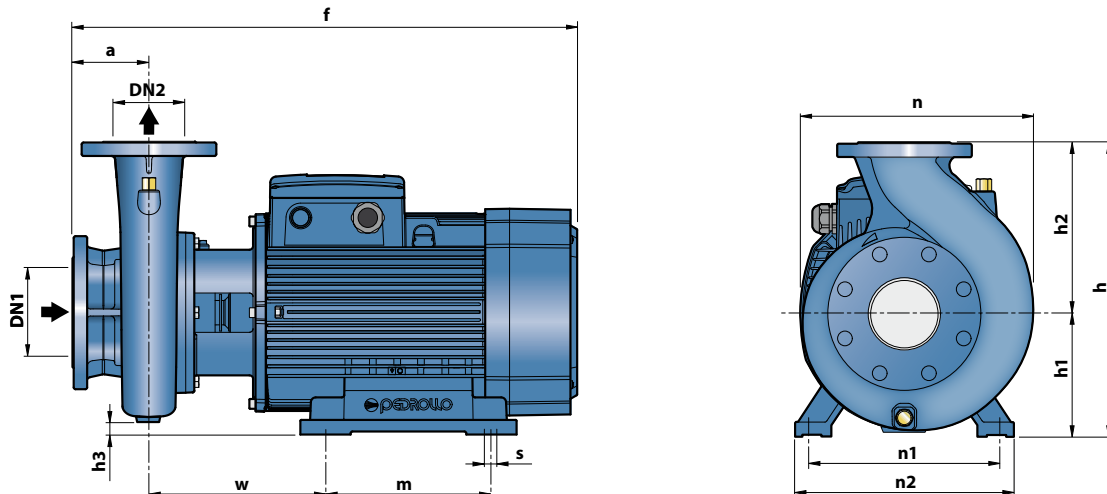

TIPO	DIMENSIONI mm														kg
	DN1	DN2	a	f	h	h1	h2	h3	n	n1	n2	w	m	s	
Trifase															
F 65/250C	80	65	100	796	450	200	250	15	369	318	360	269.5	305	18.5	201.3
F 65/250B				847											201.3
F 65/250A				847											219.3
F 80/200B	100	80	125	824	430	280	280	25	360	400	490	294	350	24	201.6
F 80/200A				875											201.6
F 80/250B				872											234.5
F 80/250A				1015	620	250	280	55	490	400	490	294	350	24	539.0
F 100/200C	125	100	140	824	480	200	280	0	391	318	360	269.5	305	18.5	225.3
F 100/200B				875											225.3
F 100/200A				875											233.3
F 100/250B				1036	620	250	280	45	490	400	490	300	350	24	539.3
F 100/250A															539.3

FLANGE DELLE BOCCHE

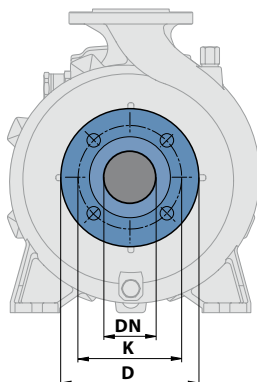

CONTROFLANGE

(ORDINABILI A PARTE)

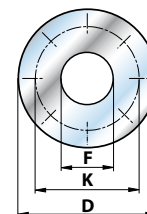

DN FLANGE	D	K	FORI	
			N°	Ø (mm)
32	140	100	4	18
40	150	110		
50	165	125		
65	185	145		
80	200	160		
100	220	180	8	
125	250	210		

DN FLANGE	F	D	K	FORI	
				N°	Ø (mm)
32	1 1/4"	140	100	4	18
40	1 1/2"	150	110		
50	2"	165	125		
65	2 1/2"	185	145		
80	3"	200	160		
100	4"	220	180	8	
125	5"	250	210		