

Elettropompe centrifughe normalizzate "EN 733"

 Acque pulite

 Uso industriale



CAMPO DELLE PRESTAZIONI

- Portata fino a **3000 l/min** (180 m³/h)
- Prevalenza fino a **24 m**

LIMITI D'IMPIEGO

- Altezza d'aspirazione manometrica fino a **7 m**
- Temperatura del liquido da **-10 °C** fino a **+90 °C**
- Temperatura ambiente da **-10 °C** fino a **+40 °C**
- Pressione max. nel corpo pompa **10 bar** (PN10)
- Servizio continuo **S1**

ESECUZIONE E NORME DI SICUREZZA

EN 60335-1
IEC 60335-1
CEI 61-150

EN 60034-1
IEC 60034-1
CEI 2-3



Dimensioni corpo pompa secondo: **EN 733**

REGOLAMENTO (UE) N. 547/2012

CERTIFICAZIONI

Azienda con sistema di gestione certificato DNV
ISO 9001: QUALITÀ
ISO 14001: AMBIENTE



UTILIZZI E INSTALLAZIONI

- Approvvigionamento idrico
- Pressurizzazione
- Irrigazione
- Circolazione acqua in impianti di climatizzazione
- Impianti di lavaggio
- Impianti antincendio
- Industria
- Agricoltura

L'installazione è da effettuarsi in luoghi chiusi o comunque protetti dalle intemperie.

ESECUZIONI A RICHIESTA

- KIT controflange comprensivo di viti, dadi e guarnizioni
- Altre tensioni o frequenza a 60 Hz
- Per liquidi con temperature più alte o più basse
- Per ambienti con temperature più alte o più basse

GARANZIA

2 anni secondo le nostre condizioni generali di vendita

CAMPO DI PRESTAZIONI

50 Hz n = 1450 rpm

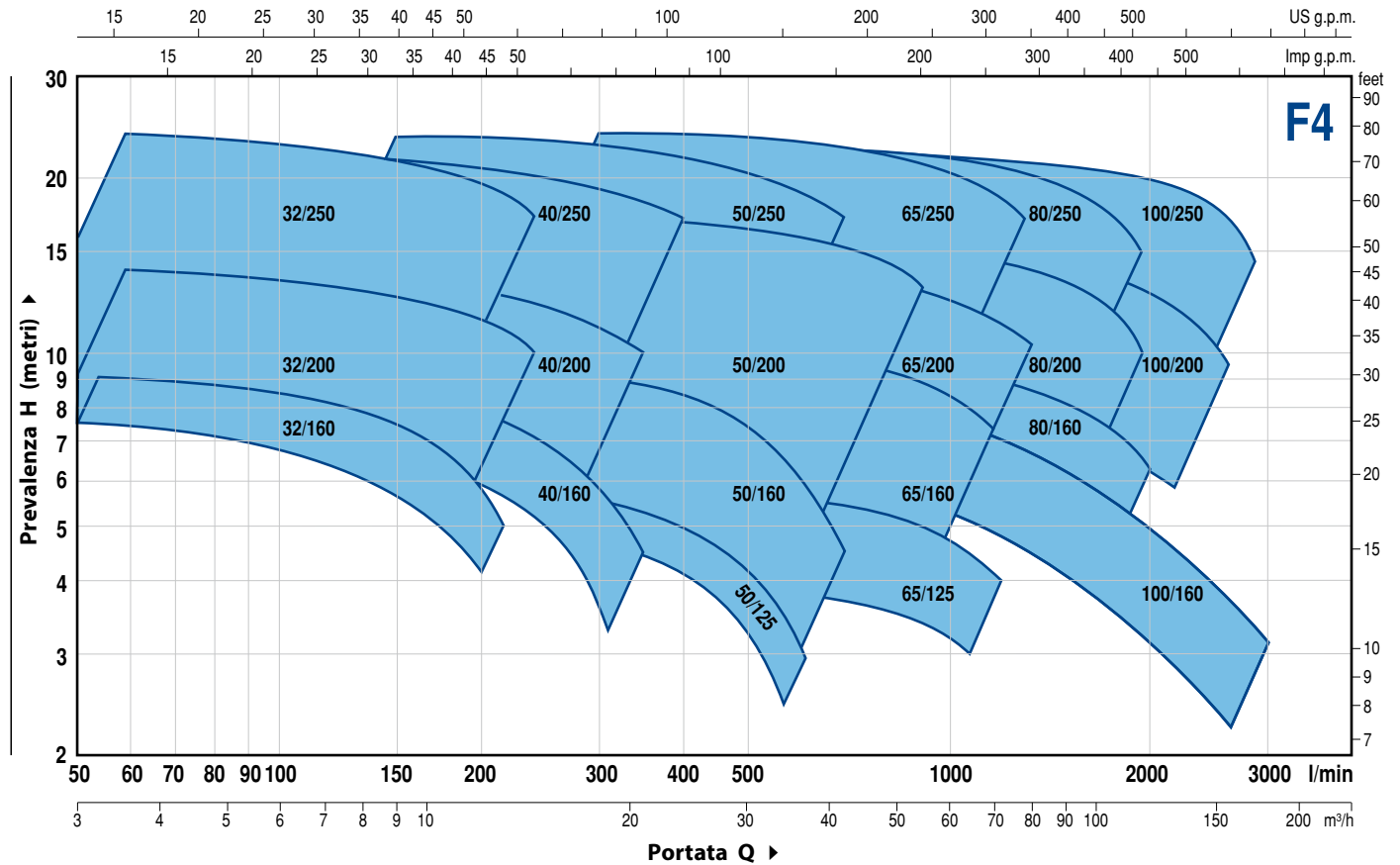

DATI DI PRESTAZIONI

50 Hz n = 1450 rpm

TIPO	POTENZA (P ₂)			PRESTAZIONI	
	kW	HP	▲	Q l/min	H metri
F4-32/160B	0.37	0.5	IE2	50 ÷ 200	7.5 ÷ 4.5
F4-32/160A	0.37	0.5		50 ÷ 225	9 ÷ 5
F4-32/200B	0.75	1	IE2	50 ÷ 250	12.5 ÷ 9
F4-32/200A	1.1	1.5		50 ÷ 250	14 ÷ 10.5
F4-32/200BH	0.75	1	IE2	50 ÷ 150	11.3 ÷ 9.2
F4-32/200AH	0.75	1		50 ÷ 160	13.8 ÷ 11
F4-32/250C	1.1	1.5	IE2	50 ÷ 200	18.5 ÷ 13.5
F4-32/250B	1.5	2		50 ÷ 225	21.5 ÷ 15.5
F4-32/250A	2.2	3	IE3	50 ÷ 250	24 ÷ 16.5
F4-40/160B	0.37	0.5	IE2	50 ÷ 320	7.5 ÷ 3.5
F4-40/160A	0.55	0.75		50 ÷ 350	9 ÷ 4.5
F4-40/200B	0.75	1	IE2	50 ÷ 350	11.5 ÷ 7
F4-40/200A	1.1	1.5		50 ÷ 350	13.8 ÷ 10
F4-40/250C	1.1	1.5	IE2	50 ÷ 400	15.5 ÷ 10
F4-40/250B	1.5	2		50 ÷ 400	17.5 ÷ 12
F4-40/250A	2.2	3	IE3	50 ÷ 400	22 ÷ 17
F4-50/125B	0.55	0.75	IE2	150 ÷ 600	5 ÷ 2
F4-50/125A	0.55	0.75		150 ÷ 600	6 ÷ 3
F4-50/160B	0.75	1	IE2	150 ÷ 650	8 ÷ 3.8
F4-50/160A	1.1	1.5		150 ÷ 700	9.3 ÷ 4.5
F4-50/200C	1.5	2	IE3	200 ÷ 850	11 ÷ 7.5
F4-50/200B	2.2	3		200 ÷ 850	13 ÷ 9.5
F4-50/200A	2.2	3		200 ÷ 900	15 ÷ 11.2
F4-50/200AR	3	4		200 ÷ 900	17 ÷ 13.2
F4-50/250D	1.1	1.5	IE2	150 ÷ 650	12.5 ÷ 5
F4-50/250C	1.5	2		150 ÷ 700	14 ÷ 5
F4-50/250B	2.2	3	IE3	150 ÷ 700	18 ÷ 10.5
F4-50/250A	2.2	3		150 ÷ 700	20 ÷ 13
F4-50/250AR	3	4		150 ÷ 700	23.5 ÷ 17

TIPO	POTENZA (P ₂)			PRESTAZIONI	
	kW	HP	▲	Q l/min	H metri
F4-65/125B	0.75	1	IE2	300 ÷ 1100	4.7 ÷ 3
F4-65/125A	1.1	1.5		300 ÷ 1200	5.7 ÷ 4
F4-65/160C	1.1	1.5	IE2	300 ÷ 1100	8 ÷ 5.5
F4-65/160B	1.5	2		300 ÷ 1200	9.1 ÷ 5.7
F4-65/160A	2.2	3	IE3	300 ÷ 1200	10.1 ÷ 7
F4-65/200A	2.2	3		300 ÷ 1250	12 ÷ 8.5
F4-65/200AR	3	4	IE3	300 ÷ 1300	14 ÷ 10
F4-65/250B	4	5.5	IE3	200 ÷ 1250	21.8 ÷ 15.5
F4-65/250A	5.5	7.5		200 ÷ 1300	23.5 ÷ 17
F4-80/160D	1.5	2	IE3	300 ÷ 2000	6.3 ÷ 2.5
F4-80/160C	2.2	3		300 ÷ 2000	7.5 ÷ 3.8
F4-80/160B	2.2	3		300 ÷ 2000	8.8 ÷ 5
F4-80/160A	3	4		300 ÷ 2000	10 ÷ 6.2
F4-80/200B	4	5.5	IE3	300 ÷ 1800	14 ÷ 9
F4-80/200A	5.5	7.5		300 ÷ 1900	15.5 ÷ 10.5
F4-80/250B	5.5	7.5	IE3	300 ÷ 1800	19.5 ÷ 13.5
F4-80/250A	7.5	10		300 ÷ 1950	22 ÷ 15
F4-100/160B-N	2.2	3	IE3	400 ÷ 2750	8.1 ÷ 2.7
F4-100/160A-N	3	4		400 ÷ 3000	9.2 ÷ 3.2
F4-100/200C	4	5.5	IE3	400 ÷ 2300	12.7 ÷ 7
F4-100/200B	5.5	7.5		400 ÷ 2400	14.2 ÷ 8.5
F4-100/200A	5.5	7.5		400 ÷ 2600	15.8 ÷ 9.5
F4-100/250B	7.5	10	IE3	400 ÷ 2600	18.5 ÷ 11.5
F4-100/250A	9.2	12.5		400 ÷ 2900	22 ÷ 13.5

Q = Portata

H = Prevalenza manometrica totale

Tolleranza delle curve di prestazioni secondo EN ISO 9906 Grado 3B.

▲ Classe di rendimento del motore trifase (IEC 60034-30)

F4-32/160

CURVE E DATI DI PRESTAZIONE

50 Hz n= 1450 rpm HS= 0 m

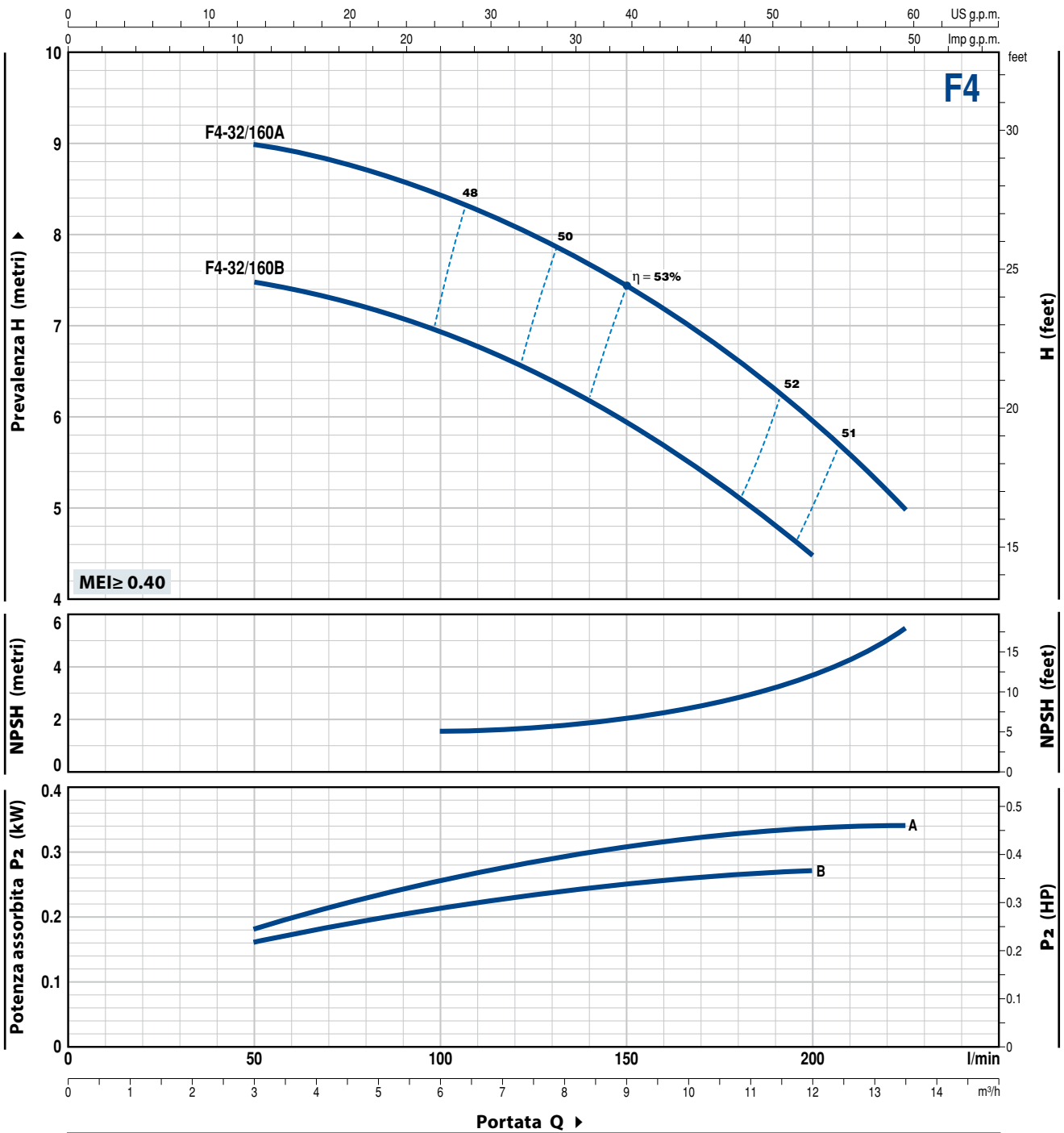

TIPO Trifase	POTENZA (P ₂)		Q m³/h l/min	3	4.5	6	7.5	9	10.8	12	13.5
	kW	HP		50	75	100	125	150	180	200	225
F4-32/160B	0.37	0.5	H metri	7.5	7.3	6.9	6.5	6	5.1	4.5	
F4-32/160A				9	8.8	8.4	8	7.5	6.6	6	5

Q = Portata H = Prevalenza manometrica totale HS = Altezza di aspirazione

Tolleranza delle curve di prestazione secondo EN ISO 9906 Grado 3B.

CURVE E DATI DI PRESTAZIONE

50 Hz n= 1450 rpm HS= 0 m

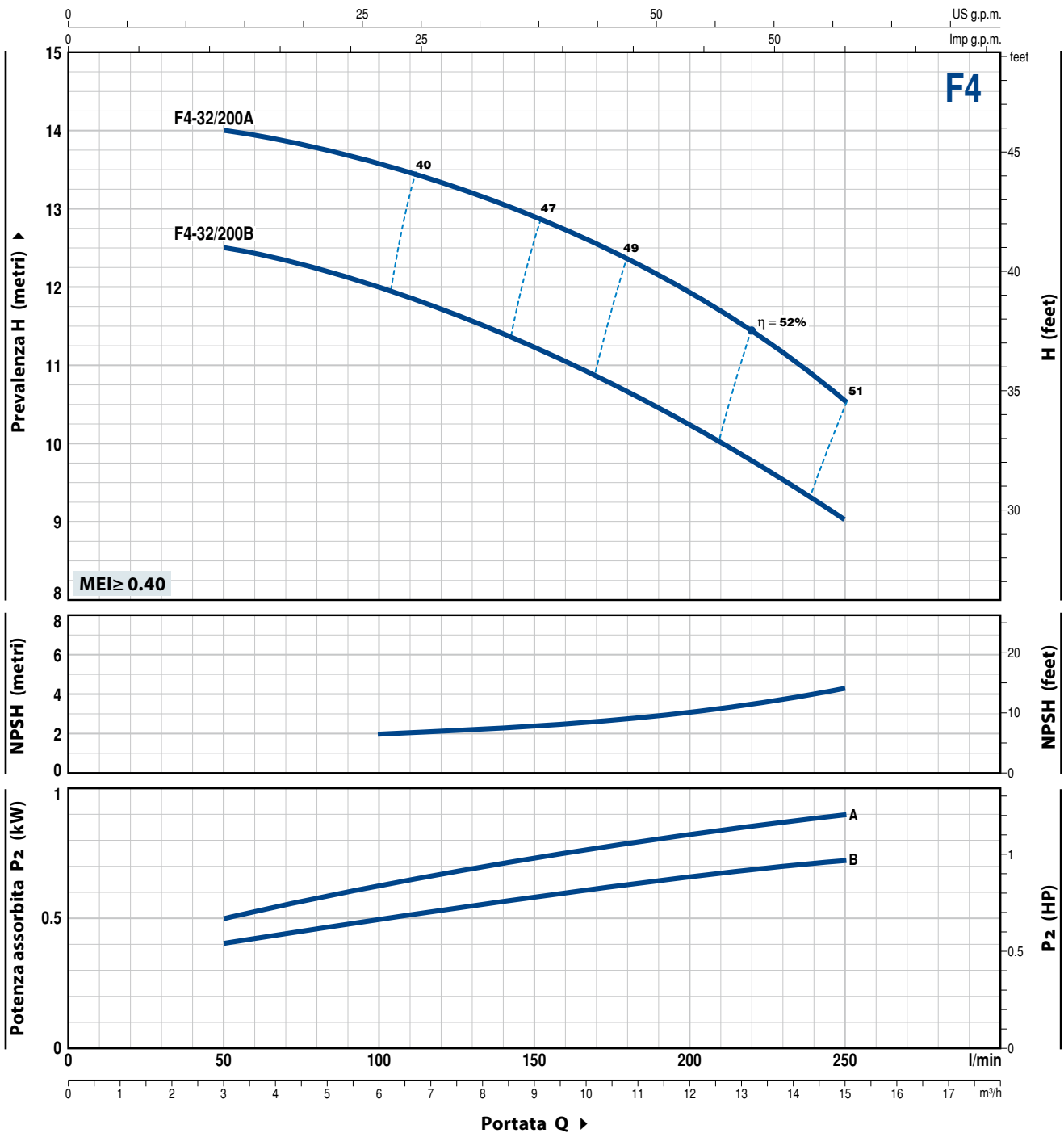

TIPO Trifase	POTENZA (P ₂)		Q m ³ /h l/min	3	6	9	12	15
	kW	HP		H metri	50	100	150	200
F4-32/200B	0.75	1	H metri	12.5	12	11.2	10.3	9
F4-32/200A	1.1	1.5	H metri	14	13,6	12.8	11.9	10.5

Q = Portata H = Prevalenza manometrica totale HS = Altezza di aspirazione

Tolleranza delle curve di prestazione secondo EN ISO 9906 Grado 3B.

F4-32/200H

CURVE E DATI DI PRESTAZIONE

50 Hz n= 1450 rpm HS= 0 m

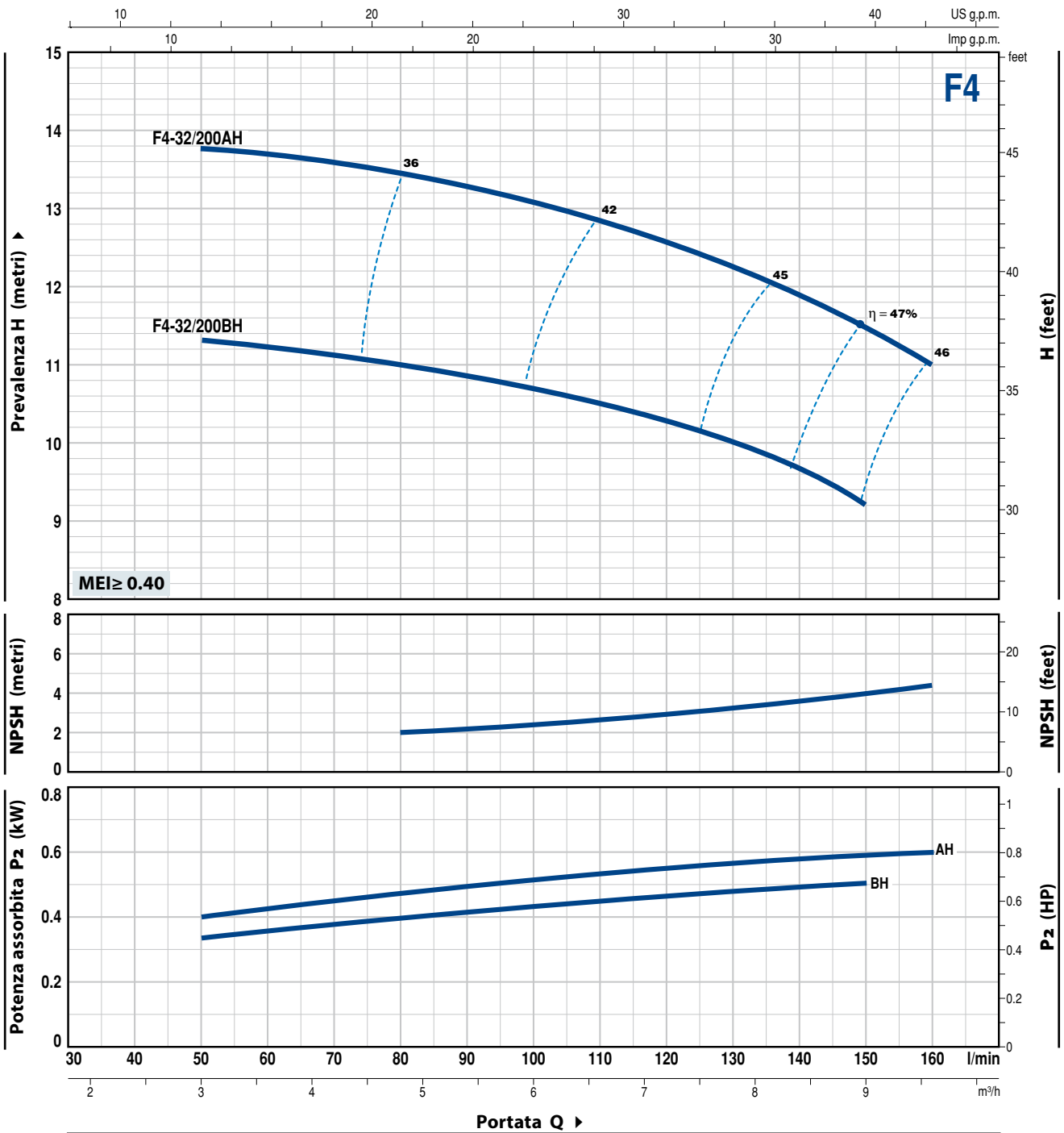

TIPO Trifase	POTENZA (P ₂)		Q m ³ /h l/min	3	4.2	5.4	6.6	7.8	9	9.6
	kW	HP		50	70	90	110	130	150	160
F4-32/200BH	0.75	1	H metri	11.3	11.1	10.8	10.5	10	9.2	
F4-32/200AH	0.75	1		13.8	13.6	13.3	12.8	12.2	11.5	11

Q = Portata H = Prevalenza manometrica totale HS = Altezza di aspirazione

Tolleranza delle curve di prestazione secondo EN ISO 9906 Grado 3B.

CURVE E DATI DI PRESTAZIONE

50 Hz n= 1450 rpm HS= 0 m

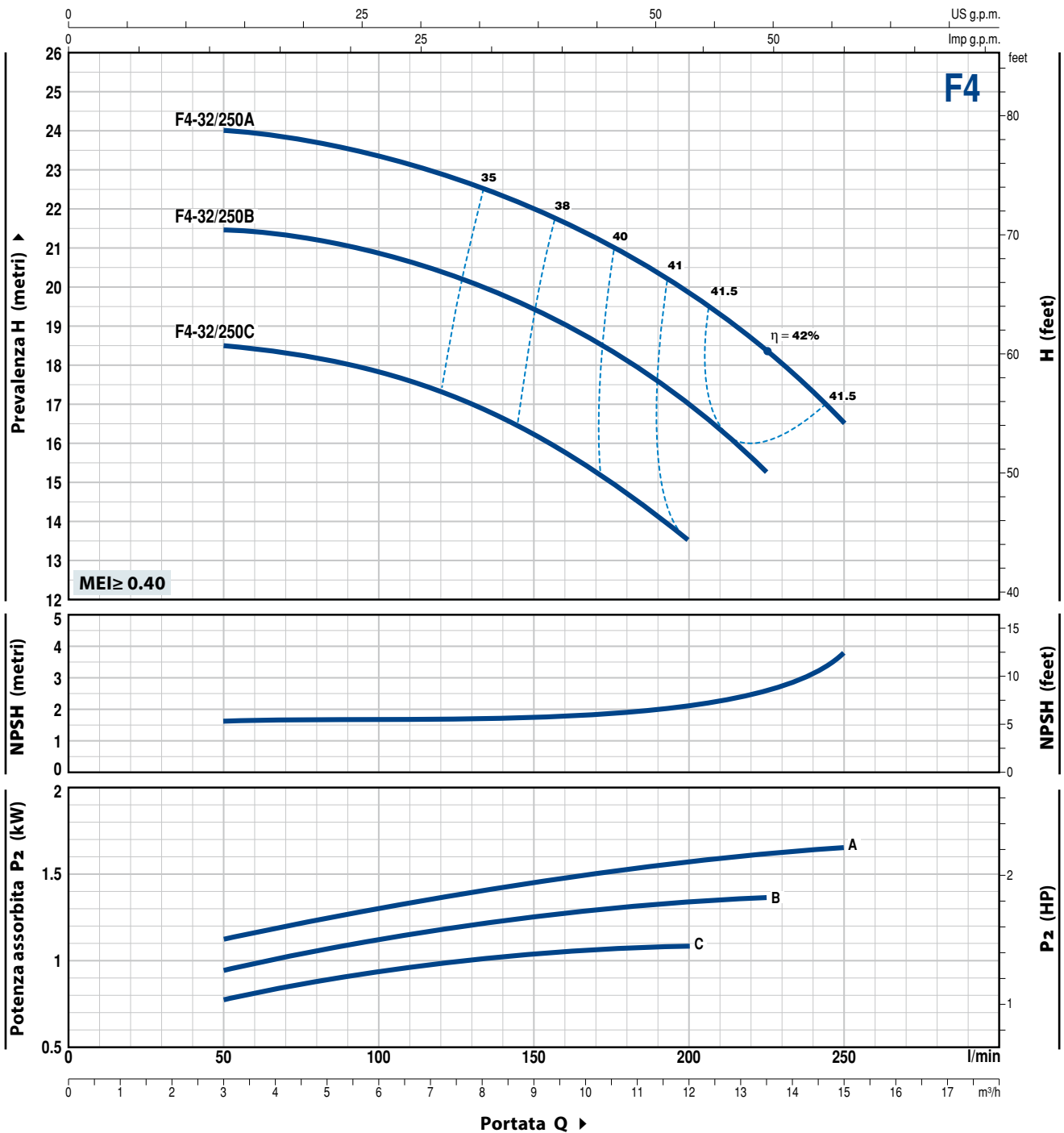

TIPO	POTENZA (P ₂)		Q	m ³ /h											
	kW	HP		3	4.5	6	7.5	9	10.5	12	13.5	15			
Trifase			Q	50	75	100	125	150	175	200	225	250			
F4-32/250C	1.1	1.5	H metri	18.5	18.2	17.8	17.2	16.2	15	13.5					
F4-32/250B	1.5	2		21.5	21.2	20.8	20.2	19.5	18.2	17	15.5				
F4-32/250A	2.2	3		24	23.7	23.3	22.7	22	21	19.8	18.3	16.5			

Q = Portata H = Prevalenza manometrica totale HS = Altezza di aspirazione

Tolleranza delle curve di prestazione secondo EN ISO 9906 Grado 3B.

F4-40/160

CURVE E DATI DI PRESTAZIONE

50 Hz n= 1450 rpm HS= 0 m

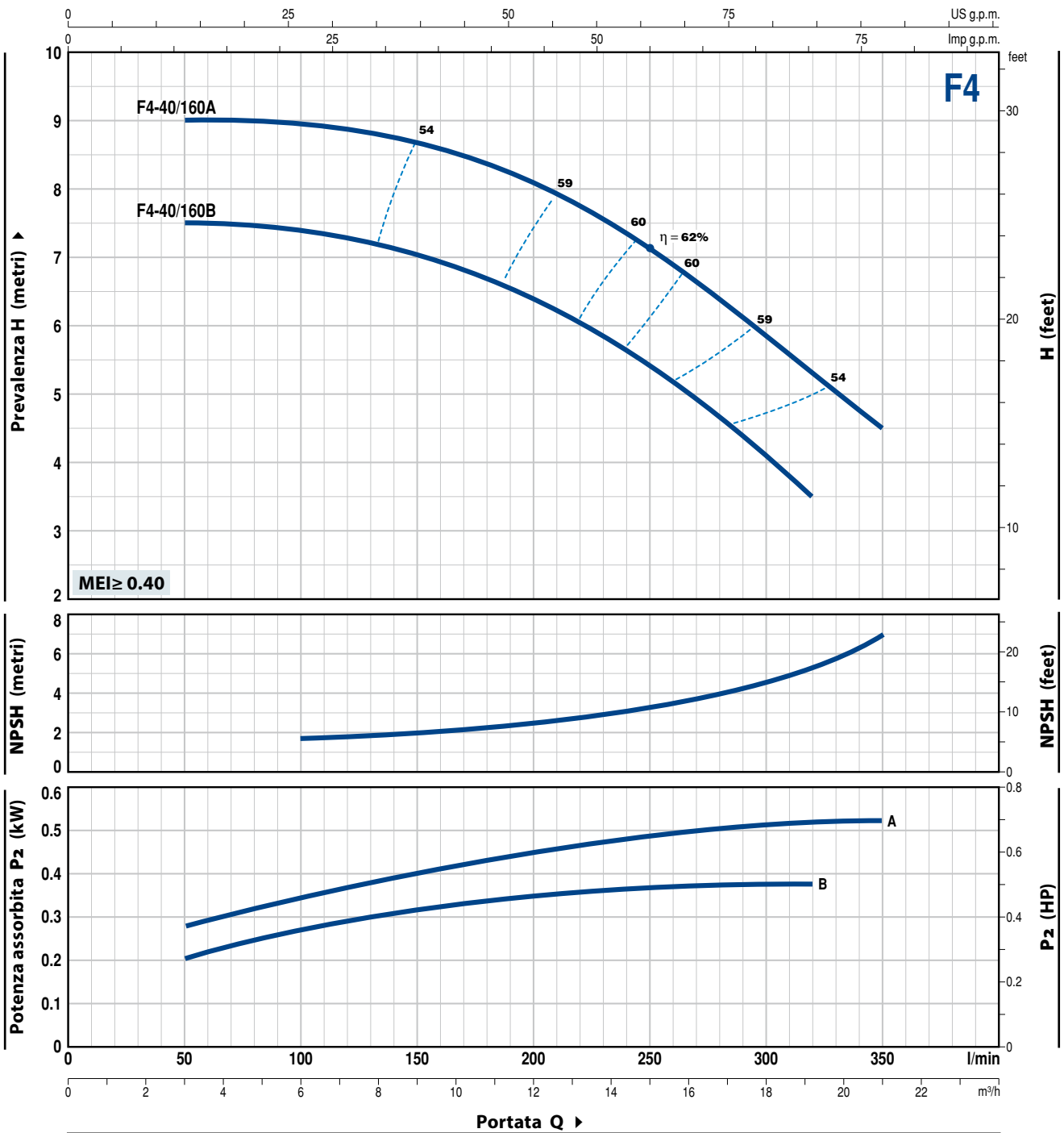

TIPO	POTENZA (P ₂)		Q	Flow Rate								
	kW	HP		m ³ /h	3	6	9	12	15	18	19.2	21
Trifase			l/min	50	100	150	200	250	300	320	350	
F4-40/160B	0.37	0.5	H metri	7.5	7.4	7	6.4	5.4	4.1	3.5		
F4-40/160A	0.55	0.75		9	8.9	8.7	8.1	7.1	5.8	5.3	4.5	

Q = Portata H = Prevalenza manometrica totale HS = Altezza di aspirazione

Tolleranza delle curve di prestazione secondo EN ISO 9906 Grado 3B.

CURVE E DATI DI PRESTAZIONE

50 Hz n= 1450 rpm HS= 0 m

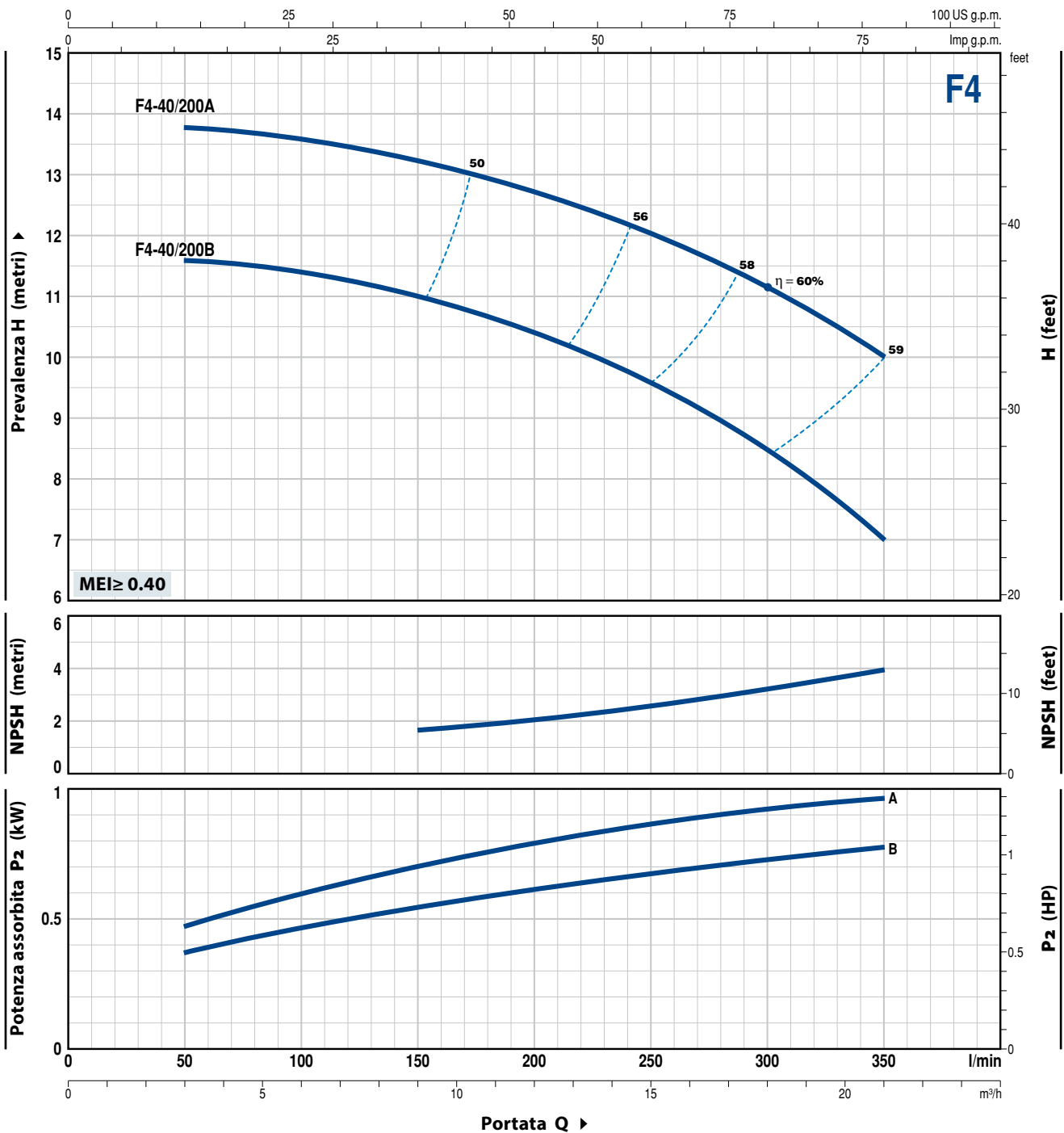

TIPO	POTENZA (P ₂)		Q	3	6	9	12	15	18	21
	kW	HP		50	100	150	200	250	300	350
F4-40/200B	0.75	1	H metri	11.5	11.4	11	10.4	9.5	8.5	7
F4-40/200A	1.1	1.5		13.8	13.6	13.2	12.7	12	11.1	10

Q = Portata H = Prevalenza manometrica totale HS = Altezza di aspirazione

Tolleranza delle curve di prestazione secondo EN ISO 9906 Grado 3B.

F4-40/250

CURVE E DATI DI PRESTAZIONE

50 Hz n= 1450 rpm HS= 0 m

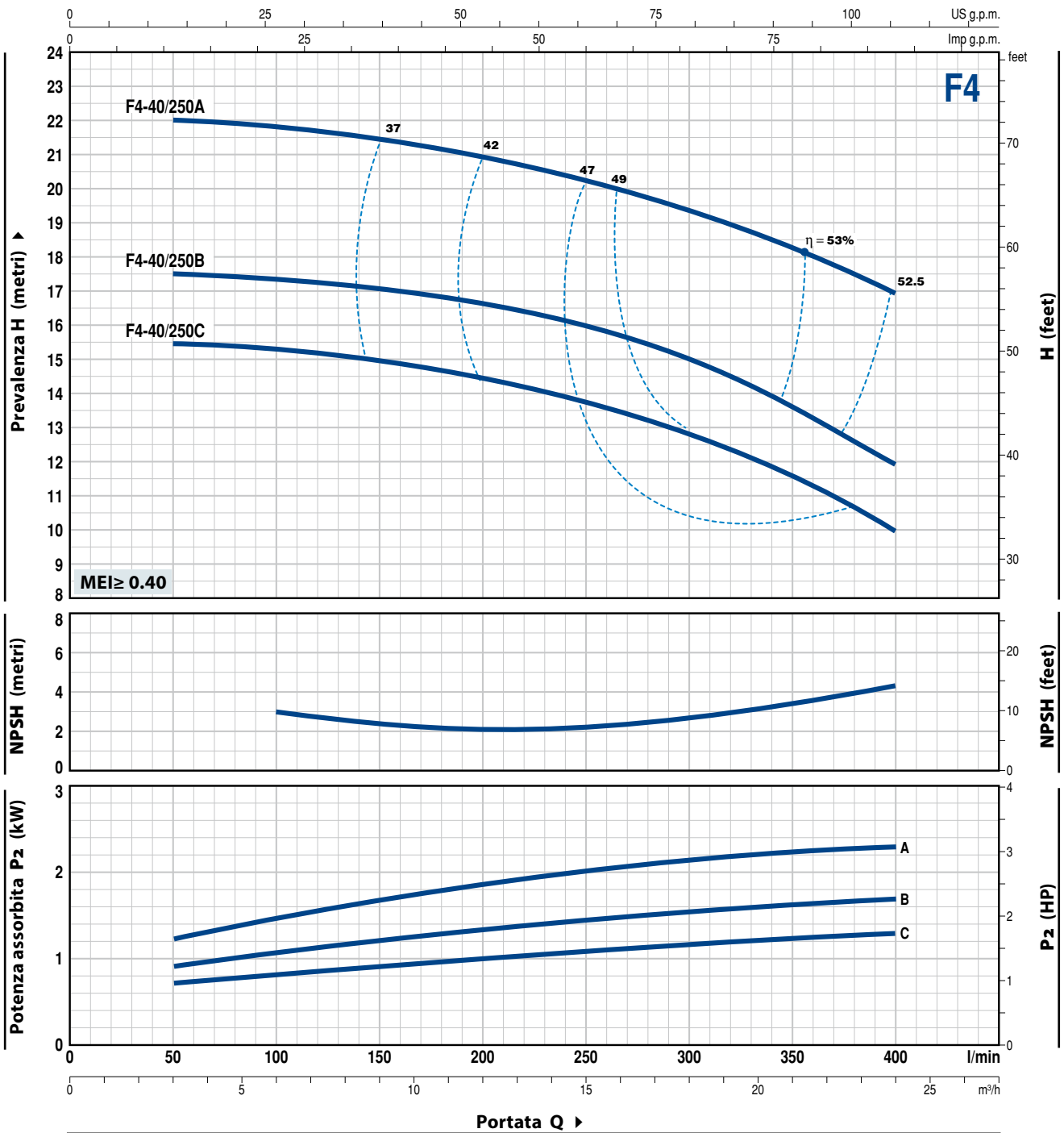

TIPO	POTENZA (P ₂)		Q	3	6	9	12	15	18	21	24	
	kW	HP		m ³ /h	l/min	50	100	150	200	250	300	350
Trifase												
F4-40/250C	1.1	1.5	H metri	15.5	15.2	15	14.5	13.6	12.9	11.5	10	
F4-40/250B	1.5	2		17.5	17.2	17	16.5	16	15	13.5	12	
F4-40/250A	2.2	3		22	21.9	21.5	21	20.2	19.2	18.2	17	

Q = Portata H = Prevalenza manometrica totale HS = Altezza di aspirazione

Tolleranza delle curve di prestazione secondo EN ISO 9906 Grado 3B.

CURVE E DATI DI PRESTAZIONE

50 Hz n= 1450 rpm HS= 0 m

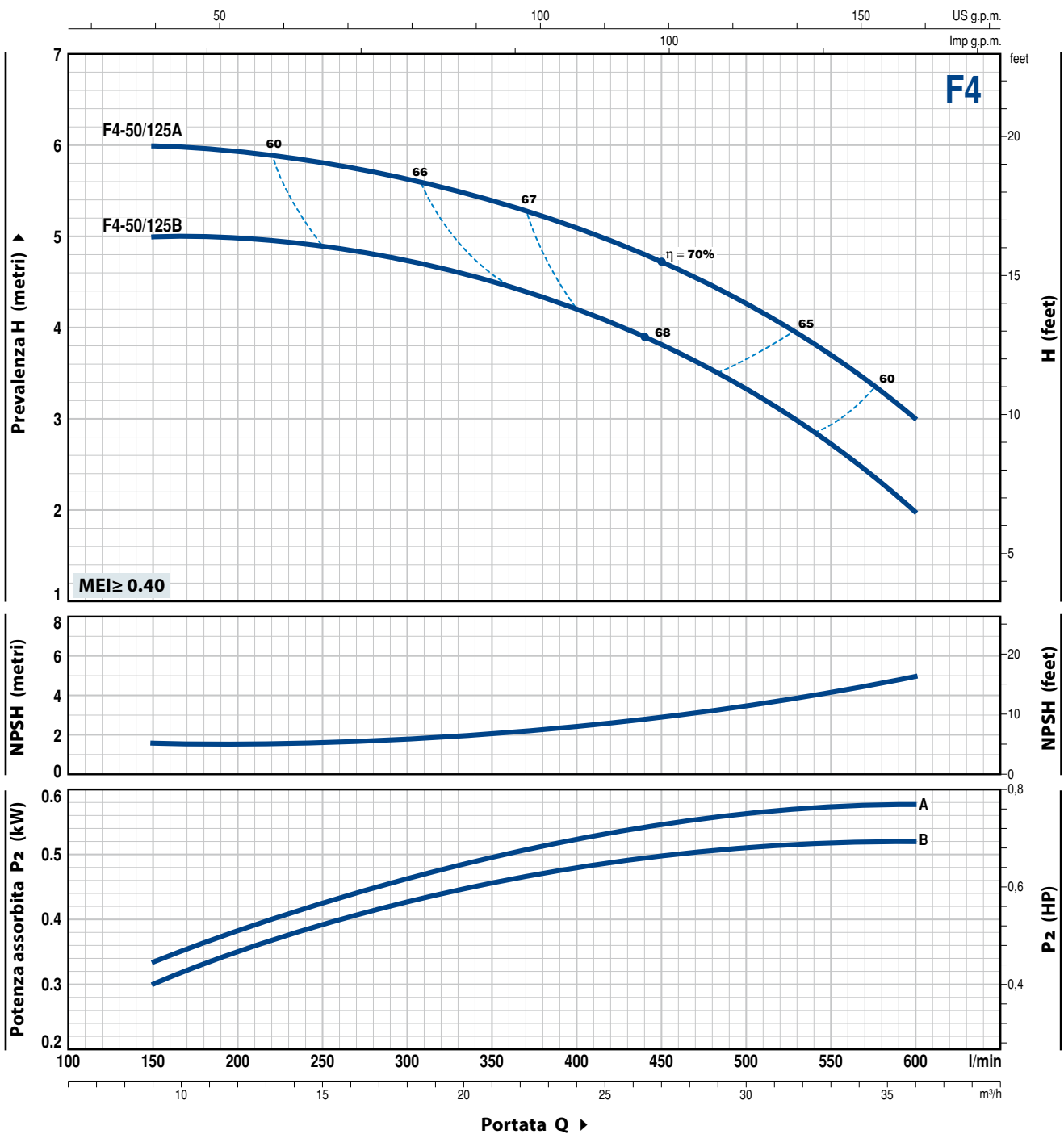

TIPO Trifase	POTENZA (P ₂)		Q m ³ /h l/min	9	12	15	17	21	24	27	30	33	36
	kW	HP		150	200	250	300	350	400	450	500	550	600
F4-50/125B	0.55	0.75	H metri	5	5	4.9	4.7	4.5	4.2	3.8	3.3	2.7	2
F4-50/125A	0.55	0.75	H metri	6	5.9	5.8	5.6	5.4	5.1	4.7	4.2	3.7	3

Q = Portata H = Prevalenza manometrica totale HS = Altezza di aspirazione

Tolleranza delle curve di prestazione secondo EN ISO 9906 Grado 3B.

F4-50/160

CURVE E DATI DI PRESTAZIONE

50 Hz n= 1450 rpm HS= 0 m

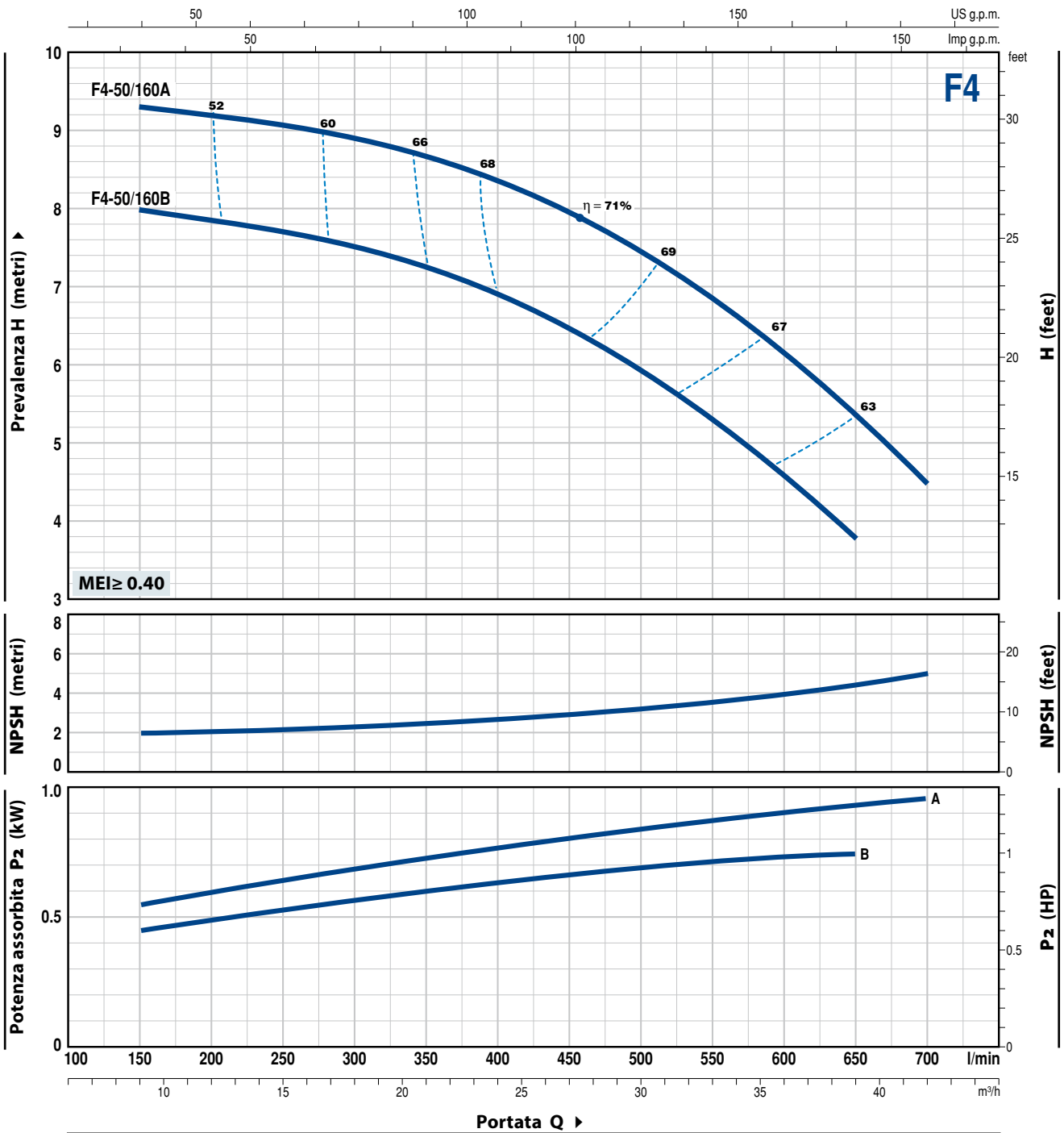

TIPO Trifase	POTENZA (P ₂)		Q m ³ /h l/min	9	12	15	17	21	24	27	30	33	36	39	42
	kW	HP		150	200	250	300	350	400	450	500	550	600	650	700
F4-50/160B	0.75	1	H metri	8	7.8	7.7	7.5	7.2	6.9	6.5	5.9	5.3	4.6	3.8	
F4-50/160A	1.1	1.5		9.3	9.2	9.1	8.9	8.7	8.4	8	7.4	6.8	6.2	5.4	4.5

Q = Portata H = Prevalenza manometrica totale HS = Altezza di aspirazione

Tolleranza delle curve di prestazione secondo EN ISO 9906 Grado 3B.

CURVE E DATI DI PRESTAZIONE

50 Hz n= 1450 rpm HS= 0 m

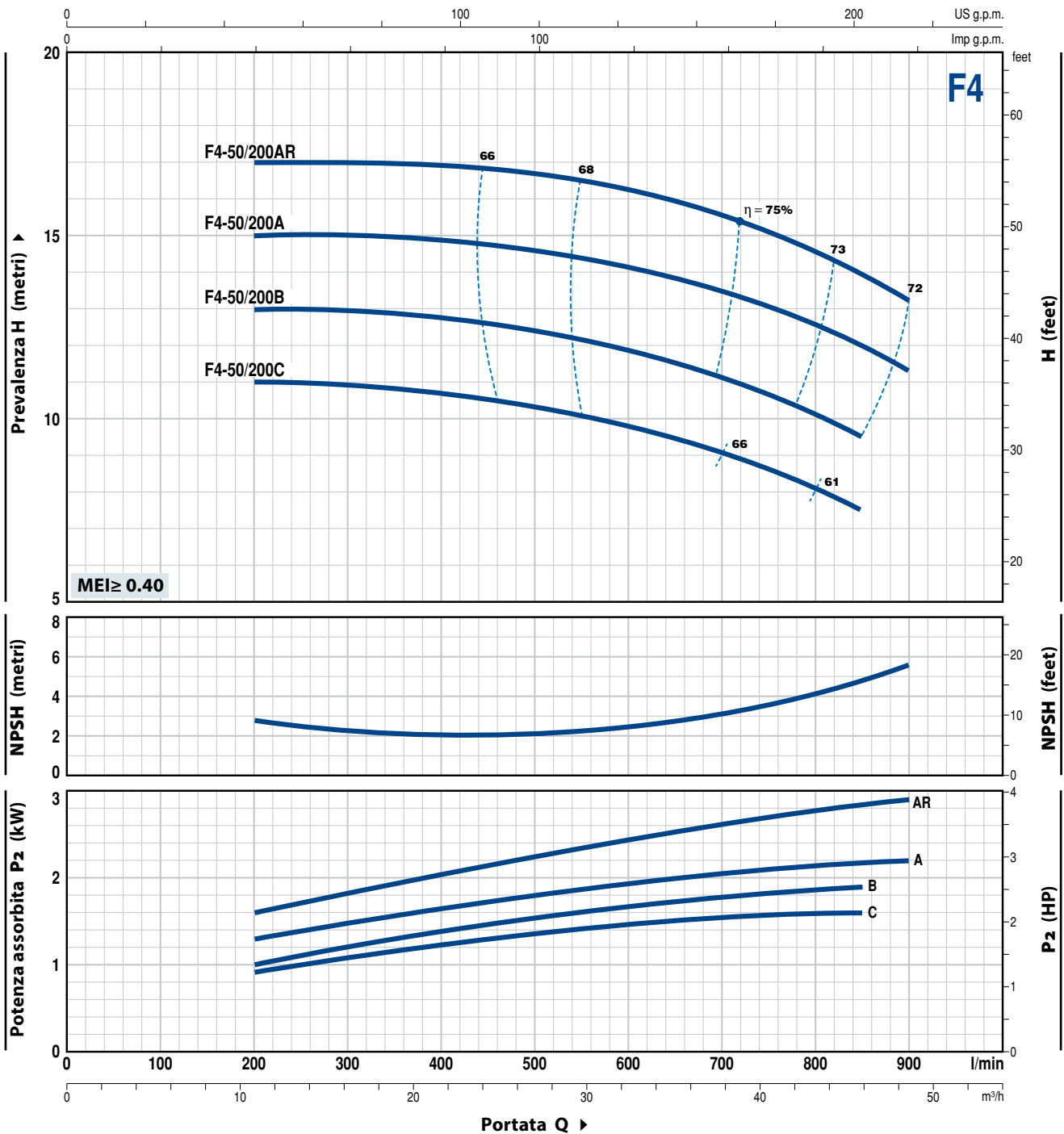

TIPO	POTENZA (P ₂)		Q	Flow Rate											
	kW	HP		m ³ /h	12	17	24	30	36	42	48	51	54		
Trifase			l/min	200	300	400	500	600	700	800	850	900			
F4-50/200C	1.5	2	H metri	11	11	10.8	10.3	9.8	9	8	7.5				
F4-50/200B	2.2	3		13	13	12.8	12.4	11.9	11.1	10.1	9.5				
F4-50/200A	2.2	3		15	15	14.9	14.6	14.1	13.5	12.5	12	11.2			
F4-50/200AR	3	4		17	17	16.9	16.7	16.2	15.5	14.5	14	13.2			

Q = Portata H = Prevalenza manometrica totale HS = Altezza di aspirazione

Tolleranza delle curve di prestazione secondo EN ISO 9906 Grado 3B.

F4-50/250

CURVE E DATI DI PRESTAZIONE

50 Hz n= 1450 rpm HS= 0 m

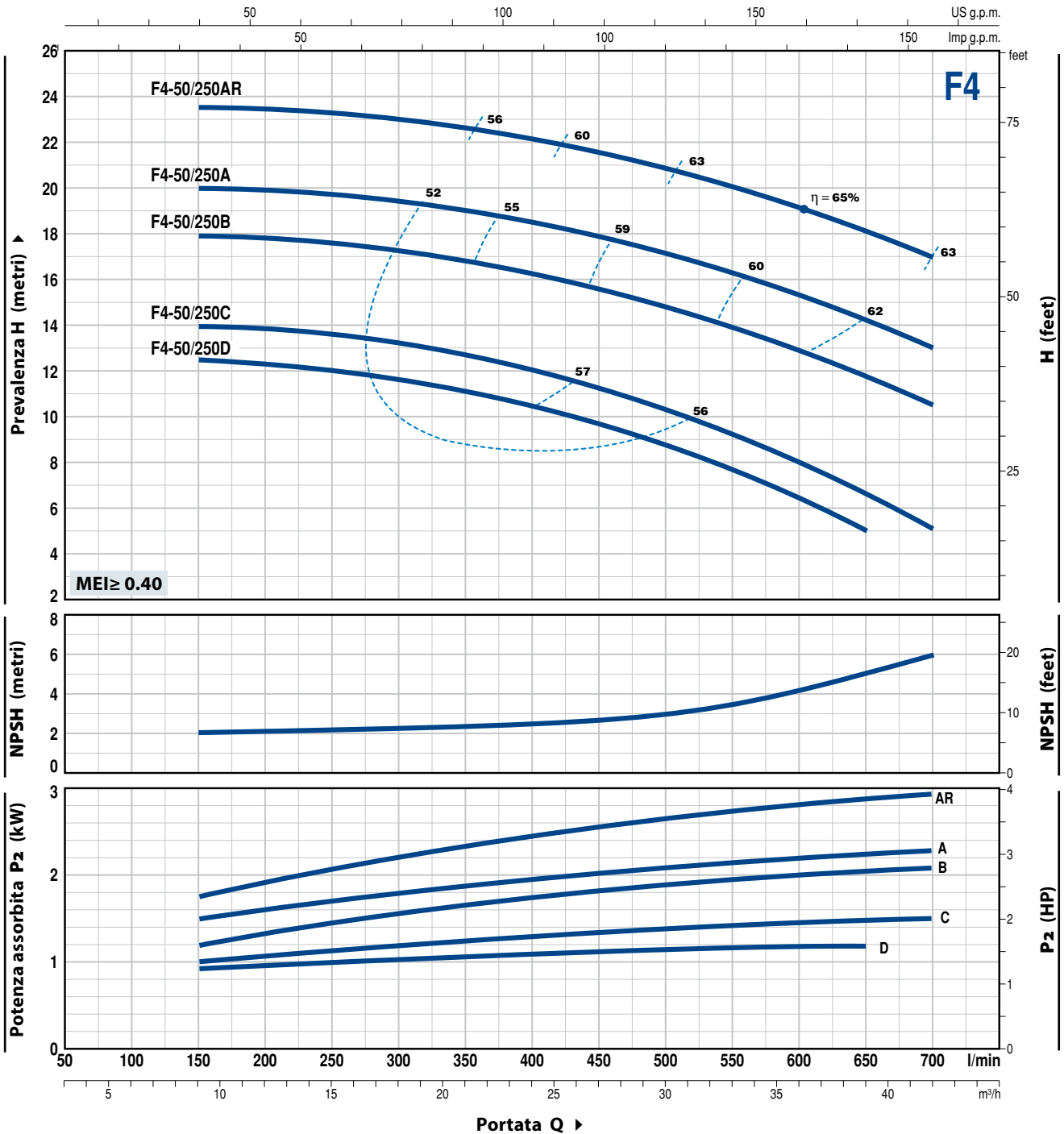

TIPO Trifase	POTENZA (P ₂)		Q m ³ /h l/min	9	12	15	18	21	24	27	30	33	36	39	42
	kW	HP		150	200	250	300	350	400	450	500	550	600	650	700
F4-50/250D	1.1	1.5	H metri	12.5	12.3	12	11.5	11.1	10.5	9.8	8.8	7.8	6.5	5	
F4-50/250C	1.5	2		14	13.9	13.6	13.2	12.8	12	11.2	10.2	9.2	8	6.6	5
F4-50/250B	2.2	3		18	17.9	17.6	17.2	16.8	16.2	15.5	14.8	14	13	11.8	10.5
F4-50/250A	2.2	3		20	19.9	19.7	19.5	19	18.5	18	17.2	16.2	15.3	14.2	13
F4-50/250AR	3	4		23.5	23.4	23.2	23	22.6	22.1	21.6	21	20	19	18	17

Q = Portata H = Prevalenza manometrica totale HS = Altezza di aspirazione

Tolleranza delle curve di prestazione secondo EN ISO 9906 Grado 3B.

CURVE E DATI DI PRESTAZIONE

50 Hz n= 1450 rpm HS= 0 m

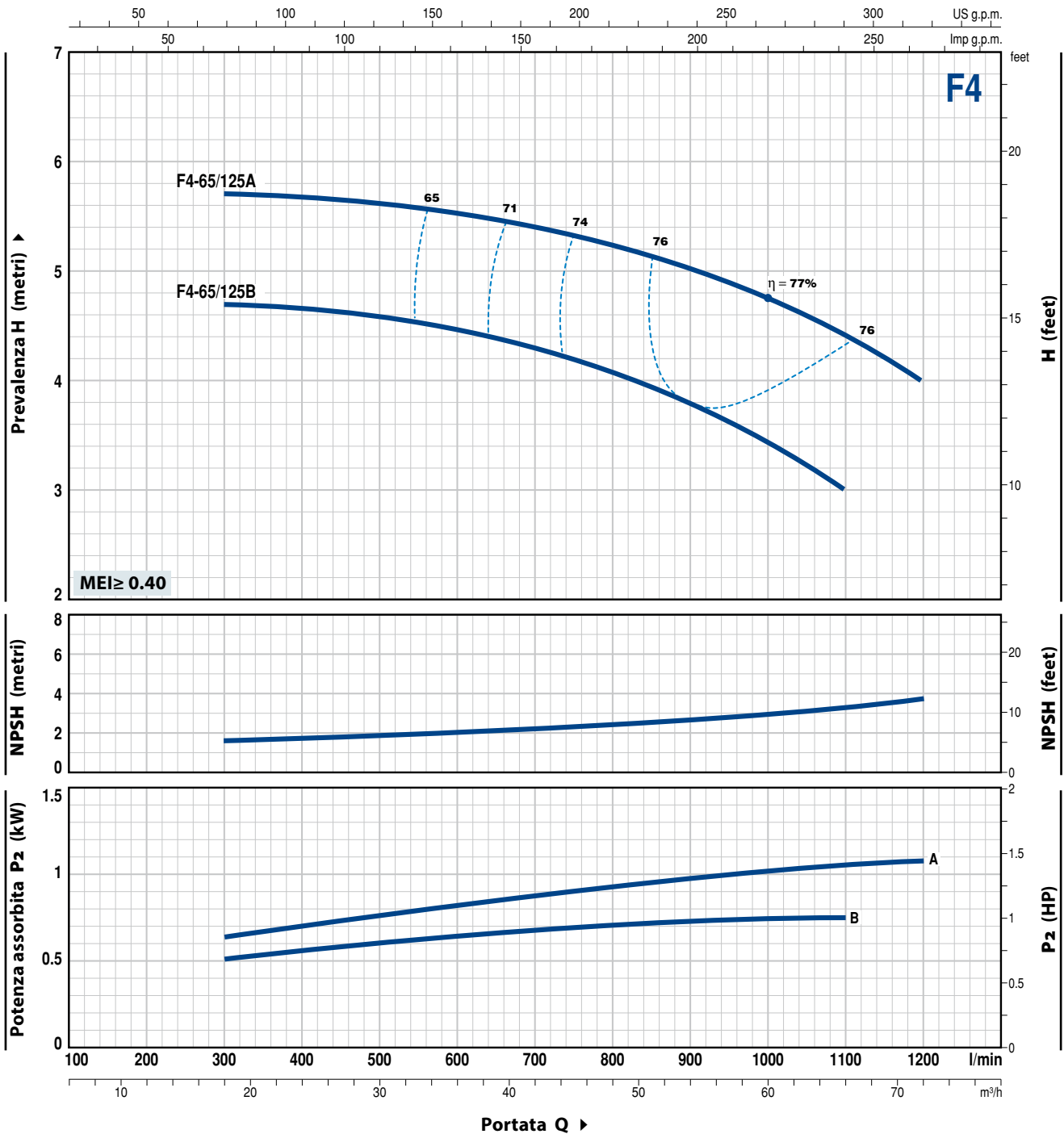

TIPO Trifase	POTENZA (P ₂)		Q m³/h l/min	18	24	30	36	42	48	54	60	66	72
	kW	HP		300	400	500	600	700	800	900	1000	1100	1200
F4-65/125B	0.75	1	H metri	4.7	4.7	4.6	4.5	4.3	4.1	3.8	3.4	3	
F4-65/125A	1.1	1.5	H metri	5.7	5.7	5.6	5.5	5.4	5.2	5	4.7	4.4	4

Q = Portata H = Prevalenza manometrica totale HS = Altezza di aspirazione

Tolleranza delle curve di prestazione secondo EN ISO 9906 Grado 3B.

F4-65/160

CURVE E DATI DI PRESTAZIONE

50 Hz n= 1450 rpm HS= 0 m

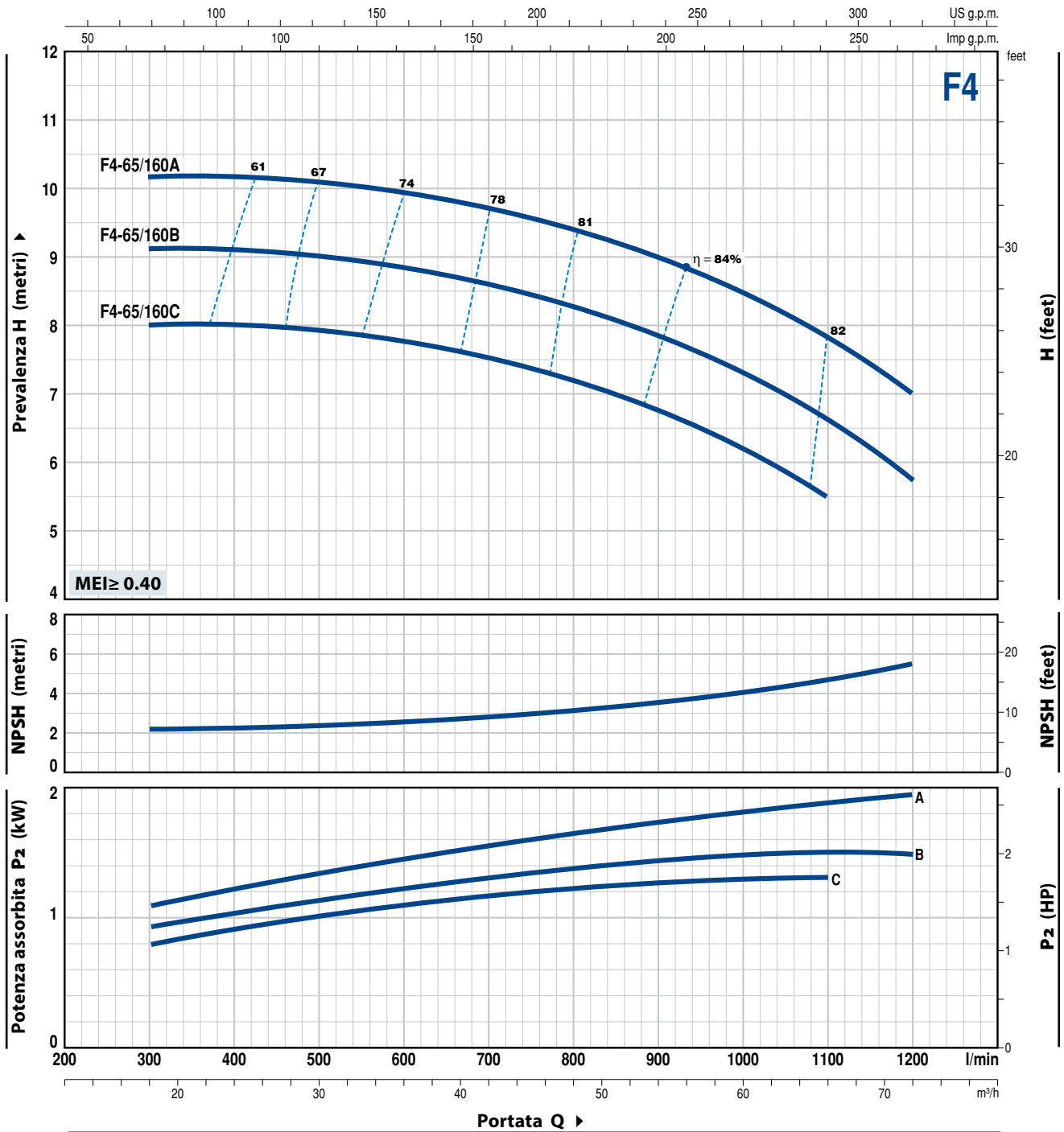

TIPO	POTENZA (P ₂)		Q	m³/h												
	kW	HP		18	24	30	36	42	48	54	60	66	72			
Trifase			l/min	300	400	500	600	700	800	900	1000	1100	1200			
F4-65/160C	1.1	1.5	H metri	8	8	7.9	7.7	7.5	7.2	6.7	6.2	5.5				
F4-65/160B	1.5	2		9.1	9.1	9	8.8	8.6	8.3	7.8	7.3	6.6	5.7			
F4-65/160A	2.2	3		10.1	10.1	10.1	9.9	9.7	9.4	9	8.5	7.8	7			

Q = Portata H = Prevalenza manometrica totale HS = Altezza di aspirazione

Tolleranza delle curve di prestazione secondo EN ISO 9906 Grado 3B.

CURVE E DATI DI PRESTAZIONE

50 Hz n= 1450 rpm HS= 0 m

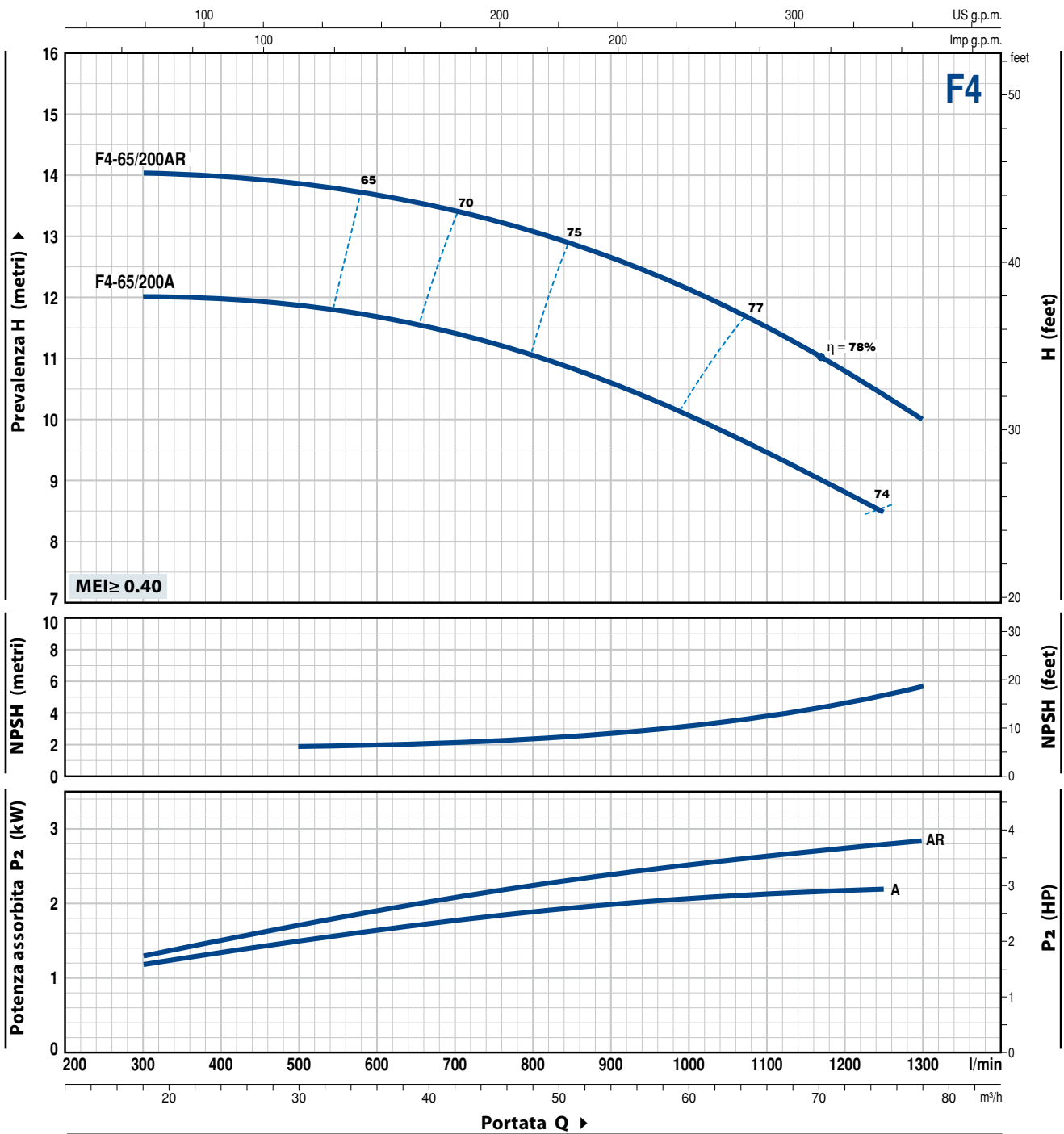

TIPO Trifase	POTENZA (P ₂)		Q m ³ /h l/min	18	24	30	36	42	48	54	60	66	72	75	78
	kW	HP		300	400	500	600	700	800	900	1000	1100	1200	1250	1300
F4-65/200A	2.2	3	H metri	12	12	11.9	11.6	11.4	11	10.6	10.1	9.5	8.8	8.5	
F4-65/200AR	3	4		14	13.9	13.8	13.6	13.4	13.1	12.7	12.1	11.5	10.8	10.3	10

Q = Portata H = Prevalenza manometrica totale HS = Altezza di aspirazione

Tolleranza delle curve di prestazione secondo EN ISO 9906 Grado 3B.

F4-65/250

CURVE E DATI DI PRESTAZIONE

50 Hz n= 1450 rpm HS= 0 m

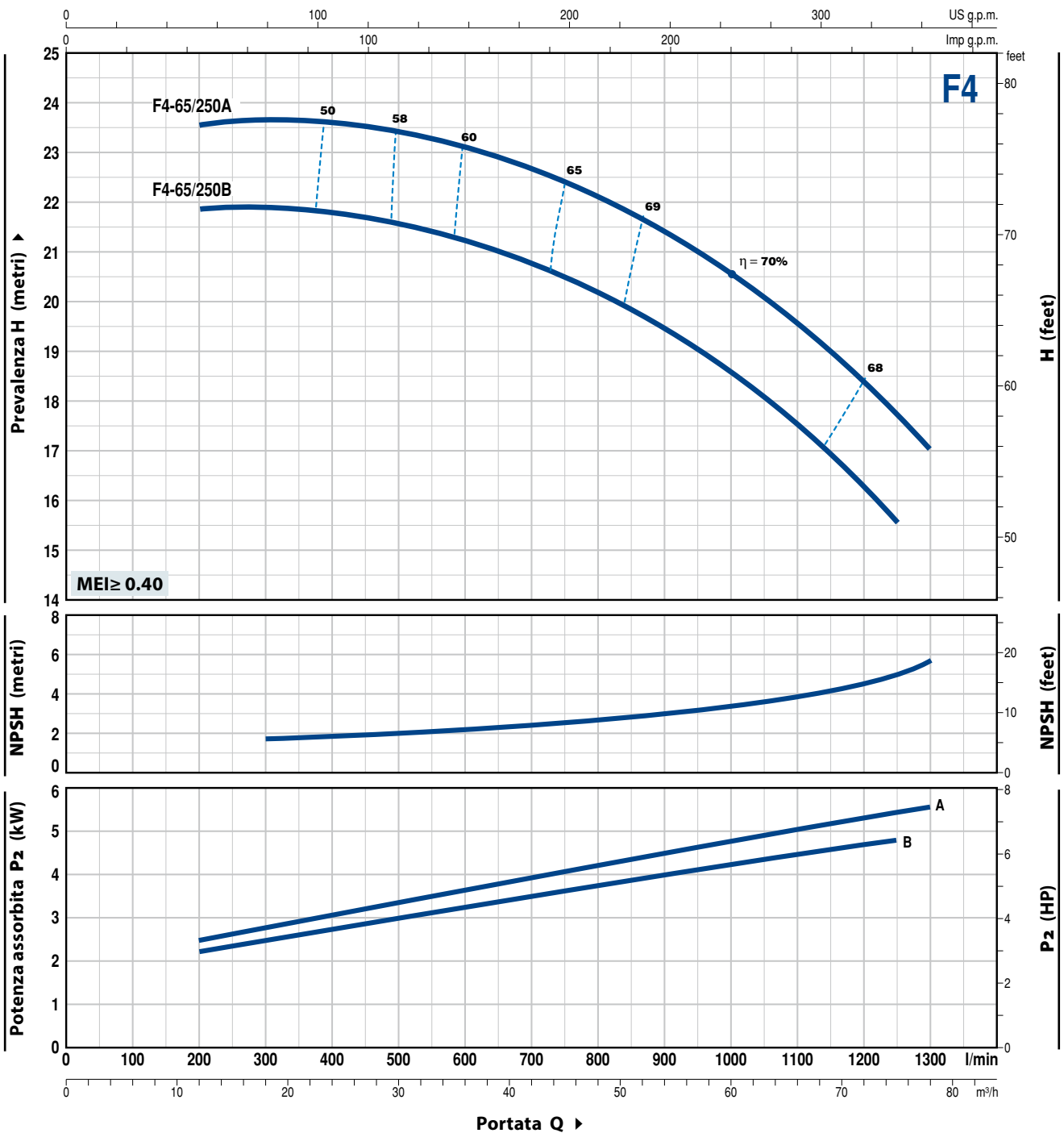

TIPO Trifase	POTENZA (P ₂)		Q m³/h l/min	12	18	24	30	36	42	48	54	60	66	72	75	78
	kW	HP		200	300	400	500	600	700	800	900	1000	1100	1200	1250	1300
F4-65/250B	4	5.5	H metri	21.8	21.8	21.7	21.5	21.2	20.7	20.2	19.5	18.6	17.5	16.2	15.5	
F4-65/250A	5.5	7.5		23.5	23.5	23.5	23.4	23.1	22.6	22.1	21.5	20.5	19.6	18.5	17.8	17

Q = Portata H = Prevalenza manometrica totale HS = Altezza di aspirazione

Tolleranza delle curve di prestazione secondo EN ISO 9906 Grado 3B.

CURVE E DATI DI PRESTAZIONE

50 Hz n= 1450 rpm HS= 0 m

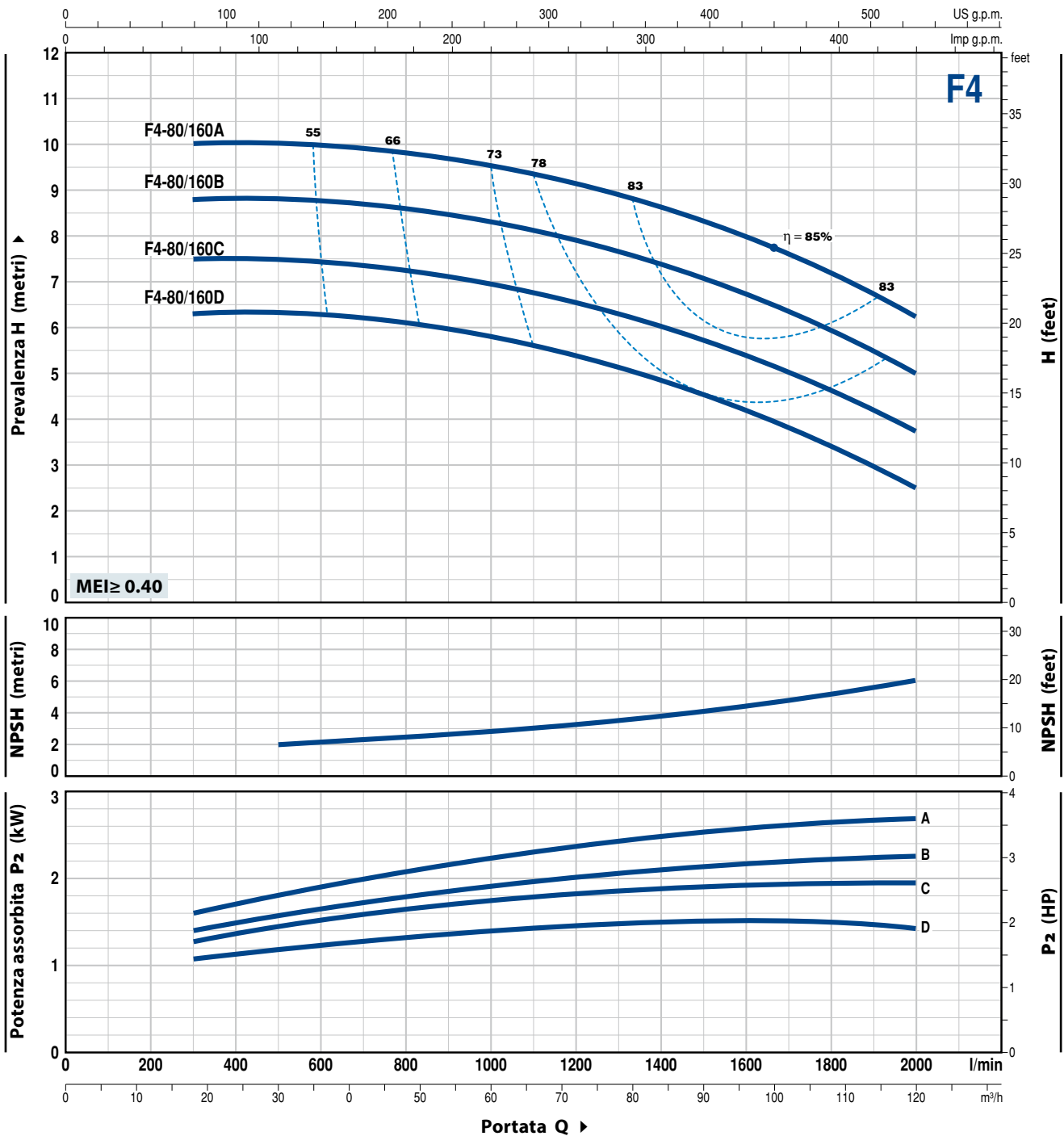

TIPO	POTENZA (P ₂)		Q	H (metri)											
	kW	HP		m ³ /h	18	24	36	48	60	72	84	96	108	120	
Trifase			l/min	300	400	600	800	1000	1200	1400	1600	1800	2000		
F4-80/160D	1.5	2		6.3	6.3	6.3	6.1	5.8	5.4	4.8	4.2	3.4	2.5		
F4-80/160C	2.2	3		7.5	7.5	7.4	7.3	6.9	6.5	6	5.4	4.6	3.8		
F4-80/160B	2.2	3		8.8	8.8	8.8	8.6	8.3	7.9	7.4	6.7	5.9	5		
F4-80/160A	3	4		10	10	10	9.8	9.5	9.1	8.6	8	7.2	6.2		

Q = Portata H = Prevalenza manometrica totale HS = Altezza di aspirazione

Tolleranza delle curve di prestazione secondo EN ISO 9906 Grado 3B.

F4-80/200

CURVE E DATI DI PRESTAZIONE

50 Hz n= 1450 rpm HS= 0 m

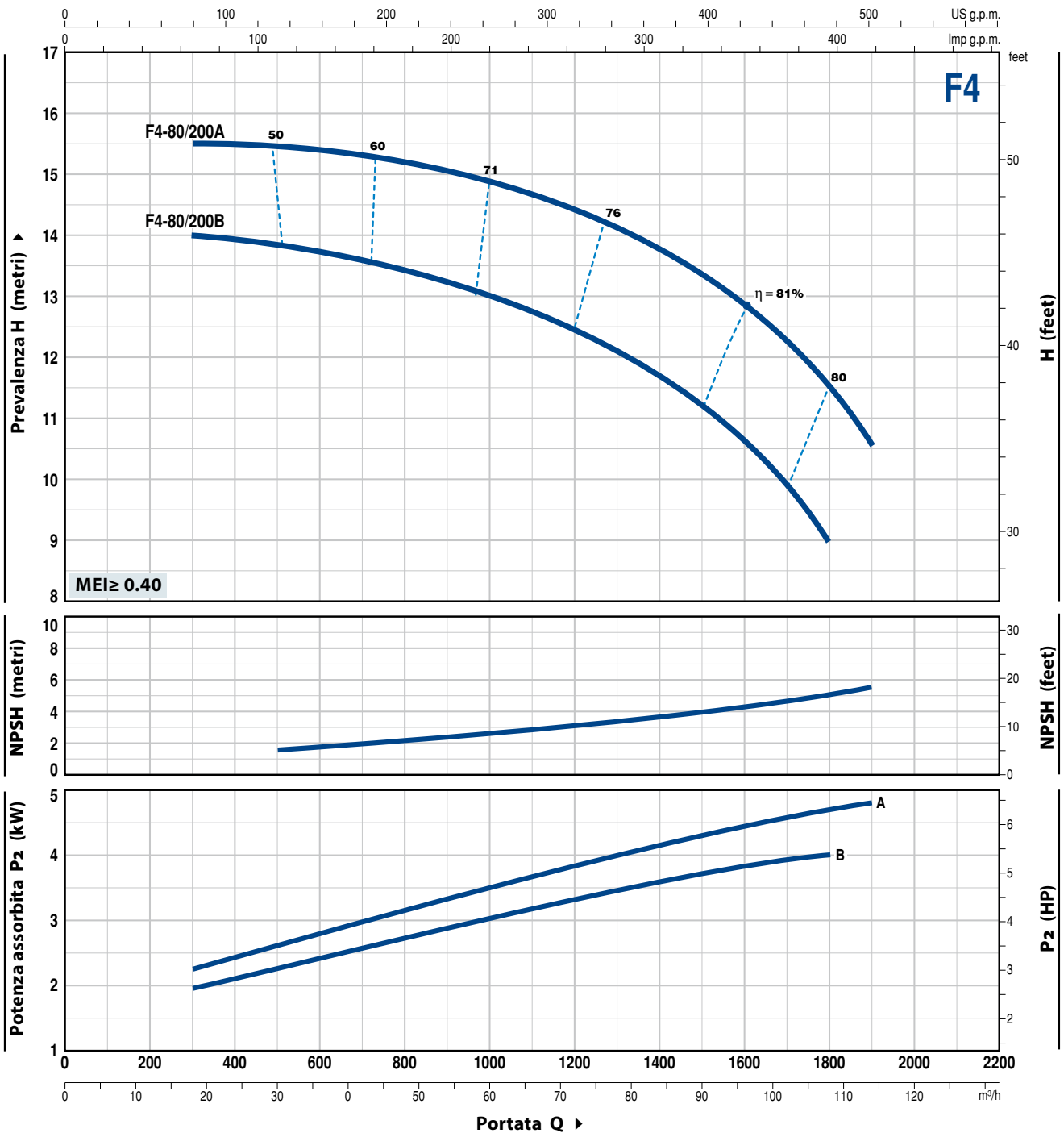

TIPO Trifase	POTENZA (P ₂)		Q m³/h l/min	18	24	36	48	60	72	84	96	108	114
	kW	HP		300	400	600	800	1000	1200	1400	1600	1800	1900
F4-80/200B	4	5.5	H metri	14	13.9	13.7	13.4	13	12.5	11.7	10.6	9	
F4-80/200A	5.5	7.5		15.5	15.5	15.4	15.2	14.8	14.5	13.7	12.8	11.5	10.5

Q = Portata H = Prevalenza manometrica totale HS = Altezza di aspirazione

Tolleranza delle curve di prestazione secondo EN ISO 9906 Grado 3B.

CURVE E DATI DI PRESTAZIONE

50 Hz n = 1450 rpm HS = 0 m

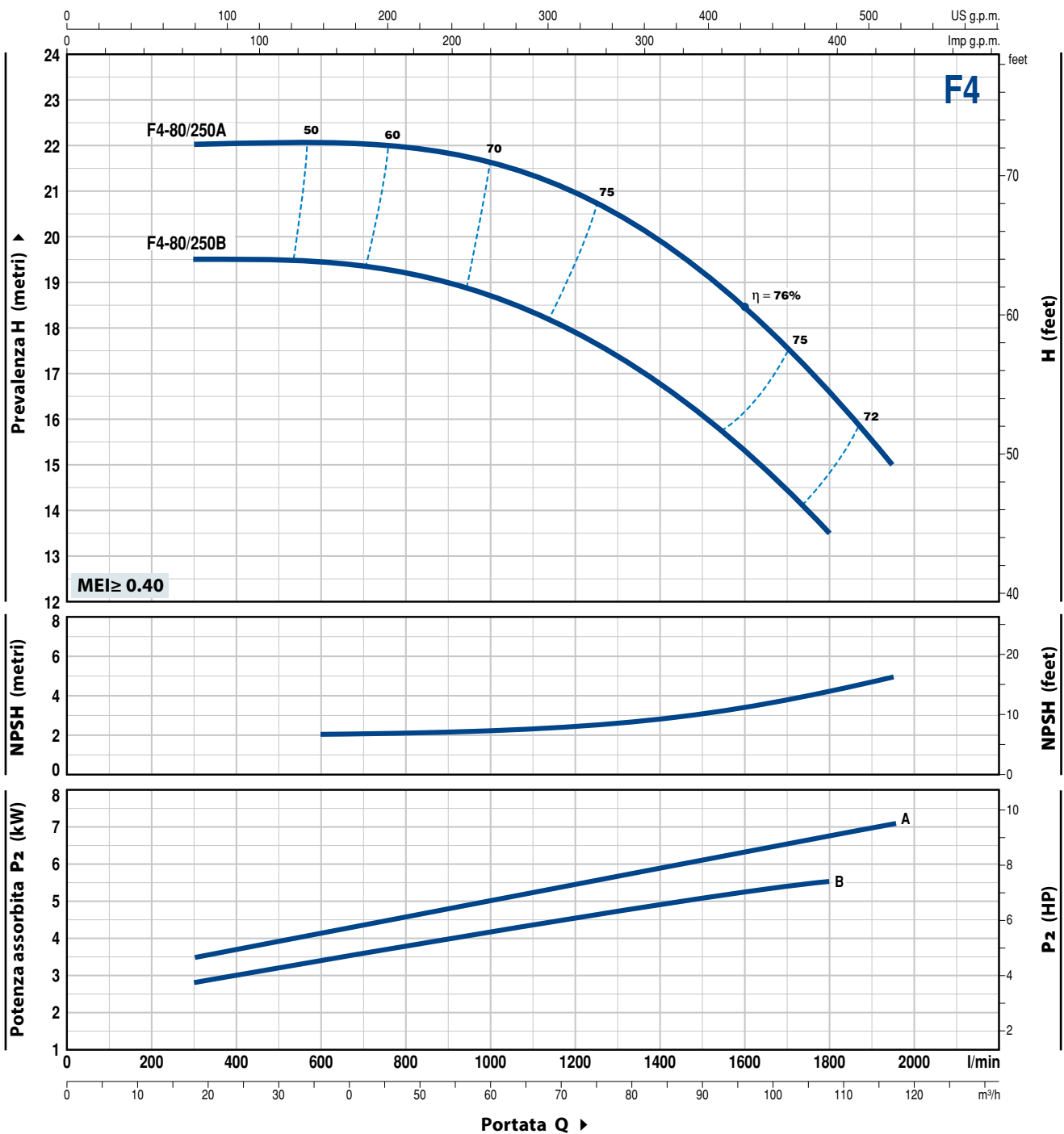

TIPO Trifase	POTENZA (P ₂)		Q m³/h l/min	18	24	36	48	60	72	84	96	108	117
	kW	HP		300	400	600	800	1000	1200	1400	1600	1800	1950
F4-80/250B	5.5	7.5	H metri	19.5	19.5	19.5	19.2	18.7	17.9	16.7	15.3	13.5	
F4-80/250A	7.5	10		22	22	22	21.9	21.6	21	20	18.5	16.5	15

Q = Portata H = Prevalenza manometrica totale HS = Altezza di aspirazione

Tolleranza delle curve di prestazione secondo EN ISO 9906 Grado 3B.

F4-100/160

CURVE E DATI DI PRESTAZIONE

50 Hz n= 1450 rpm HS= 0 m

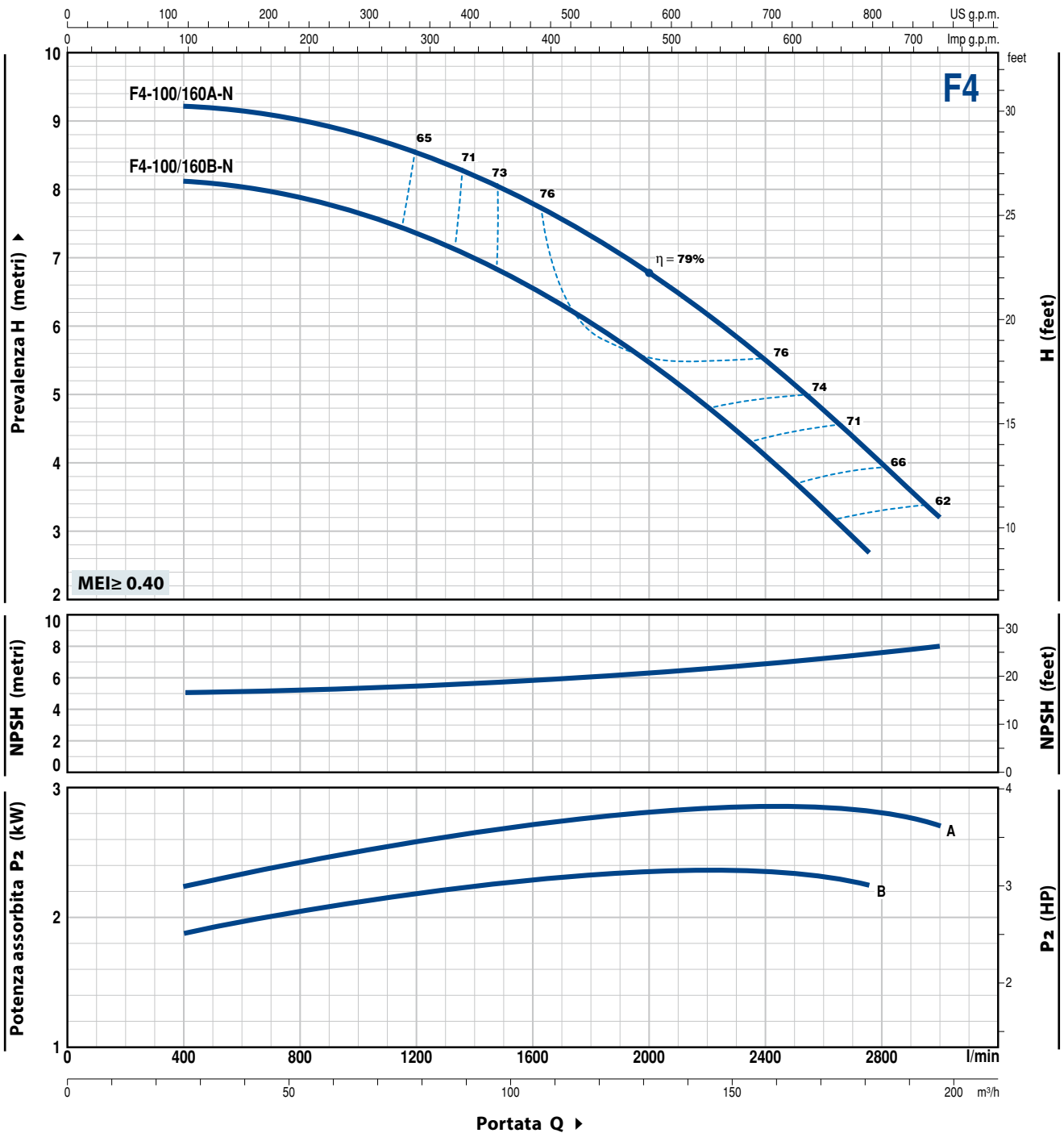

TIPO Trifase	POTENZA (P ₂)		Q m³/h l/min	24	48	72	96	120	144	165	180
	kW	HP		400	800	1200	1600	2000	2400	2750	3000
F4-100/160B-N	2.2	3	H metri	8.1	7.9	7.3	6.5	5.5	4.1	2.7	
F4-100/160A-N	3	4		9.2	9	8.5	7.8	6.8	5.5	4.2	3.2

Q = Portata H = Prevalenza manometrica totale HS = Altezza di aspirazione

Tolleranza delle curve di prestazione secondo EN ISO 9906 Grado 3B.

CURVE E DATI DI PRESTAZIONE

50 Hz n= 1450 rpm HS= 0 m

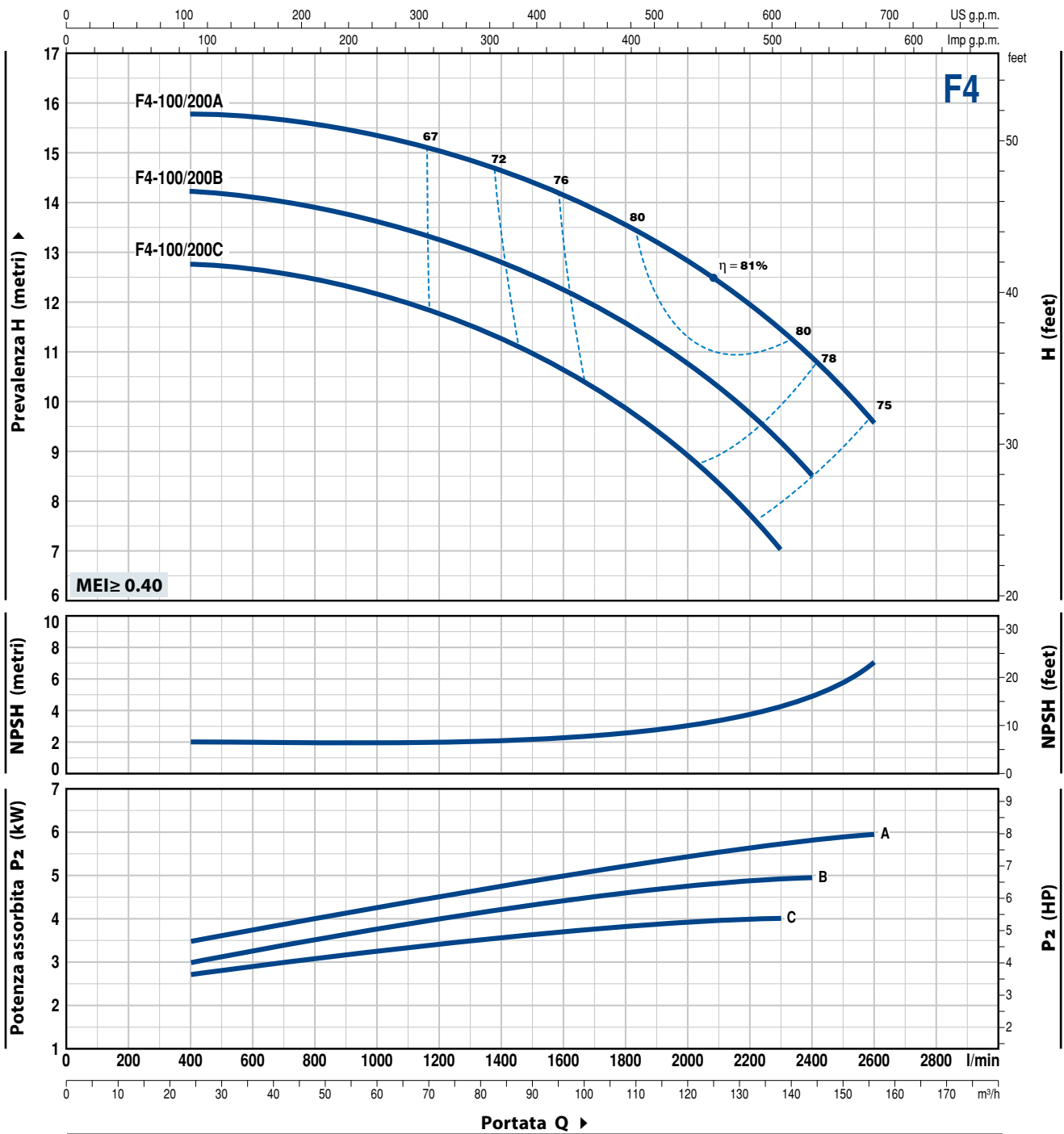

TIPO Trifase	POTENZA (P ₂)		Q m ³ /h l/min	24	36	48	60	72	84	96	108	120	138	144	156
	kW	HP		400	600	800	1000	1200	1400	1600	1800	2000	2300	2400	2600
F4-100/200C	4	5.5	H metri	12.7	12.6	12.5	12.2	11.8	11.3	10.6	9.9	8.9	7		
F4-100/200B	5.5	7.5		14.2	14.1	13.9	13.6	13.3	12.8	12.2	11.6	10.7	9.2	8.5	
F4-100/200A	5.5	7.5		15.8	15.7	15.6	15.4	15	14.6	14.2	13.5	12.8	12	11.4	9.5

Q = Portata H = Prevalenza manometrica totale HS = Altezza di aspirazione

Tolleranza delle curve di prestazione secondo EN ISO 9906 Grado 3B.

F4-100/250

CURVE E DATI DI PRESTAZIONE

50 Hz n= 1450 rpm HS= 0 m

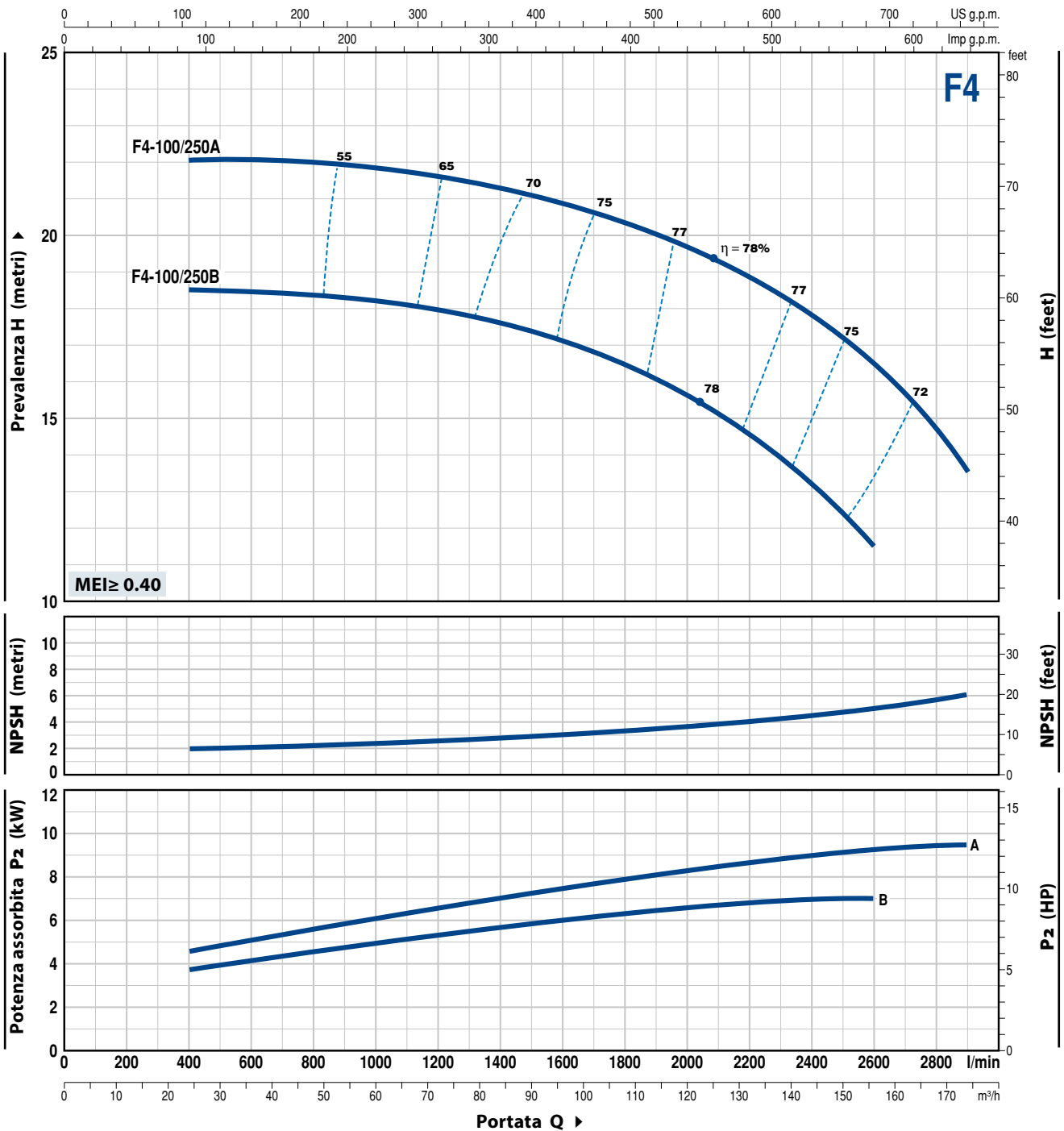

TIPO Trifase	POTENZA (P ₂)		Q m ³ /h l/min	24	36	48	60	72	84	96	108	120	132	144	156	174
	kW	HP		400	600	800	1000	1200	1400	1600	1800	2000	2200	2400	2600	2900
F4-100/250B	7.5	10	H metri	18.5	18.5	18.3	18.2	18	17.5	17.1	16.5	15.7	14.5	13.2	11.5	
F4-100/250A	9.2	12.5		22	22	22	21.8	21.6	21.2	20.9	20.3	19.7	18.9	17.9	16.5	13.5

Q = Portata H = Prevalenza manometrica totale HS = Altezza di aspirazione

Tolleranza delle curve di prestazione secondo EN ISO 9906 Grado 3B.

POS. COMPONENTE CARATTERISTICHE COSTRUTTIVE

1	CORPO POMPA	Ghisa, provvisto di bocche di aspirazione e di mandata flangiate					
2	COPERCHIO	Ghisa					
3	GIRANTE	Ottone per F4-32/160, 32/200, 40/160, 40/200, 50/125, 50/160					
3	GIRANTE	Ghisa per F4-32/250, 40/250, 50/200, 50/250, 65/125, 65/160, 65/200, 65/250, F4-80/160, 80/200, 80/250, 100/160, 100/200, 100/250					
4	ALBERO MOTORE	Acciaio inox EN 10088-3 - 1.4104					
5	TENUTA MECCANICA	Elettropompa	Tenuta	Albero	Materiali		
		Tipo	Tipo	Diametro	Anello fisso	Anello rotante	Elastomero
		F4-32/160 F4-50/125 F4-40/160	FN-20	Ø 20 mm	Grafite	Ceramica	NBR
		F4-32/200 F4-50/160 F4-40/200 F4-65/125	FN-24	Ø 24 mm	Grafite	Ceramica	NBR
		F4-50/200 F4-80/160 F4-65/200 F4-100/160 F4-65/160	FN-32 NU	Ø 32 mm	Grafite	Ceramica	NBR
		F4-32/250 F4-50/250 F4-40/250	FN-38	Ø 38 mm	Grafite	Ceramica	NBR
		F4-65/250 F4-100/200 F4-80/200	FN-40 NU	Ø 40 mm	Grafite	Ceramica	NBR
		F4-80/250 F4-100/250	FN-45 NU	Ø 45 mm	Grafite	Ceramica	NBR
6	CUSCINETTI	Elettropompa	Tipo	Elettropompa	Tipo		
		F4-32/160 F4-40/160 F4-50/125	6206 ZZ-C3 / 6204 ZZ	F4-32/250 F4-40/250 F4-50/200 F4-50/250 F4-65/160 F4-65/200 F4-80/160 F4-100/160	6208 ZZ-C3 / 6206 ZZ-C3		
		F4-32/200 F4-40/200 F4-50/160 F4-65/125	6307 ZZ-C3 / 6206 ZZ-C3	F4-65/250 F4-80/200 F4-80/250 F4-100/200 F4-100/250	6310 ZZ-C3 / 6308 ZZ-C3		
7	MOTORE ELETTRICO	F4: a 4 poli trifase 230/400 V - 50 Hz					
		<p>► Le elettropompe sono equipaggiate con motori ad alto rendimento in classe IE2 fino a P₂=1.1 kW e in classe IE3 da P₂=1.5 kW (IEC 60034-30)</p> <p>– Isolamento: classe F</p> <p>– Protezione: IP 55</p>					

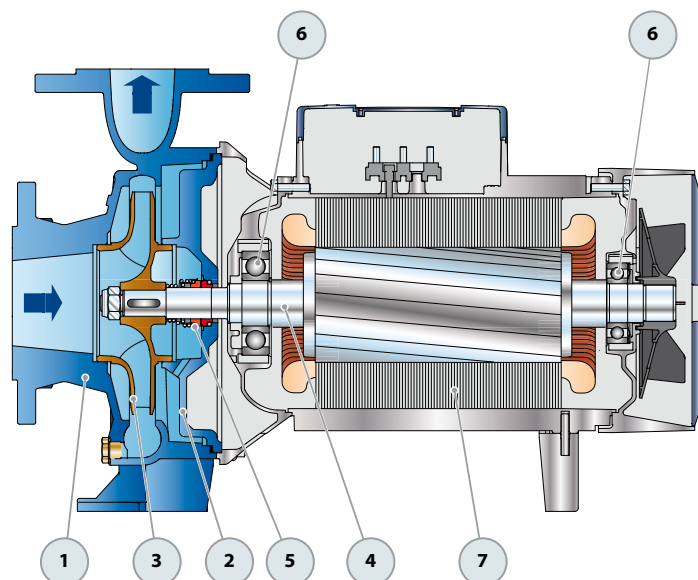

DIMENSIONI E PESI

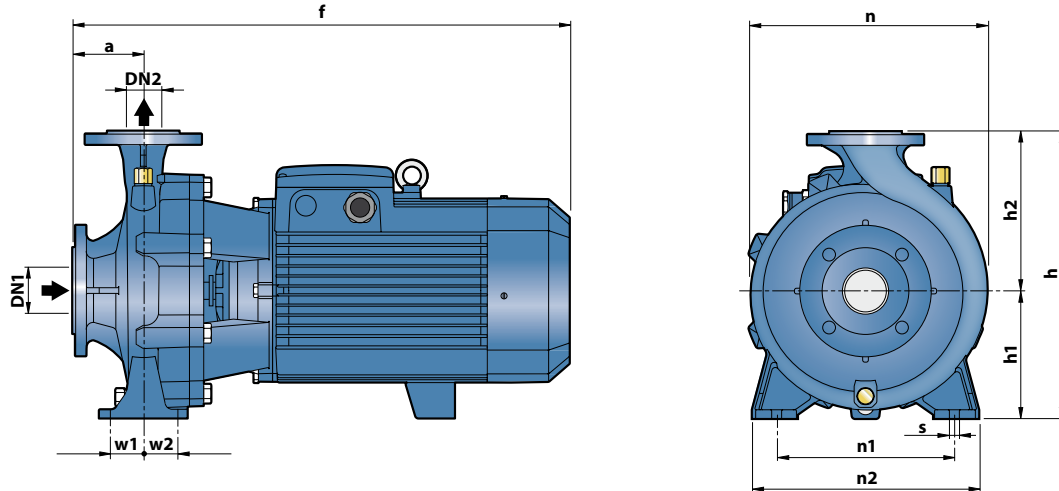

TIPO	DIMENSIONI mm											kg																
	DN1	DN2	a	f	h	h1	h2	n	n1	n2	w1		w2	s														
Trifase																												
F4-32/160B	50	32	80	412	292	132	160	242	190	240	35	35	14	31.2														
F4-32/160A																31.3												
F4-32/200B																	43.4											
F4-32/200A																	43.5											
F4-32/200BH					100	469	340	160	180	270	250	320		405	47.5	42.3												
F4-32/200AH																	42.4											
F4-32/250C						522	405	180	225	330						330	330	330	330	330	59.7							
F4-32/250B						568															63.1							
F4-32/250A													68.7															
F4-40/160B	65	40	80	412	292	132	160	240	190	240	35	35	14	32.5														
F4-40/160A																			32.9									
F4-40/200B																					46.0							
F4-40/200A																					46.1							
F4-40/250C					100	489	340	160	180	275	212	265		47.5	47.5	59.7												
F4-40/250B						522	405	180	225	328						250	320	47.5	47.5	63.1								
F4-40/250A						568															68.7							
F4-50/125B						100	431	292	132	160						242	190	240	35	35	14	32.2						
F4-50/125A														32.3														
F4-50/160B														44.4														
F4-50/160A														44.5														
F4-50/200C										212	265	47.5	47.5	18	59.2													
F4-50/200B																			64.4									
F4-50/200A				576	360			200	316							64.7												
F4-50/200AR																68.8												
F4-50/250D				522											59.9													
F4-50/250C															63.3													
F4-50/250B				568	405	180	225	337	250	320	47.5	47.5			68.7													
F4-50/250A															69.1													
F4-50/250AR														73.2														
F4-65/125B	80	65	100	511	340	160	180	291	212	280	47.5	47.5	14	51.0														
F4-65/125A																									51.1			
F4-65/160C																	533	360		200	300					55.5		
F4-65/160B																	579									63.7		
F4-65/160A																	69.0											
F4-65/200A							582	405	180	225	340	250		320				73.0										
F4-65/200AR																		123.8										
F4-65/250B							627	450	200	250	373	280		360	60	60	18	139.6										
F4-65/250A				722										62.1														
F4-80/160D	100	80	125	565					362	280	360			18	70.7													
F4-80/160C																											78.1	
F4-80/160B																		611	405	180	225	330	250	320	47.5	47.5	14	114.4
F4-80/160A																		655	430		250	360	280	345				130.2
F4-80/200B							750											149.5										
F4-80/200A																		166.0										
F4-80/250B							768	480	200	280	405	315	400		60	60	18	173.5										
F4-80/250A																		182.9										
F4-100/160B-N	125	100	125	622					391	280	360	60	60	18	70.7													
F4-100/160A-N																											78.1	
F4-100/200C																		657	480	200		280	360					124.1
F4-100/200B																		752										139.8
F4-100/200A																		140.1										
F4-100/250B							789	505	225		422	315	400					173.5										
F4-100/250A				821										182.9														

FLANGE DELLE BOCCHE

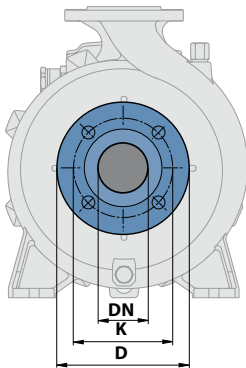

CONTROFLANGE

(ORDINABILI A PARTE)

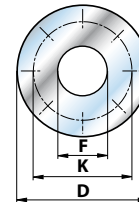

DN FLANGE mm	D mm	K mm	FORI	
			N°	Ø (mm)
32	140	100	4	18
40	150	110		
50	165	125		
65	185	145		
80	200	160	8	
100	220	180		
125	250	210		

DN FLANGE mm	F CONTROFLANGE	D mm	K mm	FORI	
				N°	Ø (mm)
32	1¼"	140	100	4	18
40	1½"	150	110		
50	2"	165	125		
65	2½"	185	145		
80	3"	200	160	8	
100	4"	220	180		
125	5"	250	210		

ASSORBIMENTI

TIPO	TENSIONE	
	230÷240 V	400÷415 V
Trifase		
F4-32/160B	1.9 A	1.1 A
F4-32/160A	2.3 A	1.3 A
F4-32/200B	3.6 A	2.1 A
F4-32/200A	4.0 A	2.3 A
F4-32/200BH	3.1 A	1.8 A
F4-32/200AH	3.5 A	2.0 A
F4-32/250C	4.5 A	2.6 A
F4-32/250B	5.7 A	3.3 A
F4-32/250A	9.0 A	5.2 A
F4-40/160B	2.1 A	1.2 A
F4-40/160A	2.8 A	1.6 A
F4-40/200B	3.6 A	2.1 A
F4-40/200A	4.2 A	2.4 A
F4-40/250C	4.5 A	2.6 A
F4-40/250B	6.1 A	3.5 A
F4-40/250A	9.0 A	5.2 A
F4-50/125B	2.4 A	1.4 A
F4-50/125A	2.6 A	1.5 A
F4-50/160B	3.6 A	2.1 A
F4-50/160A	4.2 A	2.4 A
F4-50/200C	6.1 A	3.5 A
F4-50/200B	8.0 A	4.6 A
F4-50/200A	9.0 A	5.2 A
F4-50/200AR	11.8 A	6.8 A
F4-50/250D	4.5 A	2.6 A
F4-50/250C	5.9 A	3.4 A
F4-50/250B	8.5 A	4.9 A
F4-50/250A	9.9 A	5.7 A
F4-50/250AR	11.8 A	6.8 A

TIPO	TENSIONE	
	230÷240 V	400÷415 V
Trifase		
F4-65/125B	3.6 A	2.1 A
F4-65/125A	4.5 A	2.6 A
F4-65/160C	4.7 A	2.7 A
F4-65/160B	5.9 A	3.4 A
F4-65/160A	7.8 A	4.5 A
F4-65/200A	9.0 A	5.2 A
F4-65/200AR	11.8 A	6.8 A
F4-65/250B	16.4 A	9.5 A
F4-65/250A	23.4 A	13.5 A
F4-80/160D	5.9 A	3.4 A
F4-80/160C	8.1 A	4.7 A
F4-80/160B	9.2 A	5.3 A
F4-80/160A	11.8 A	6.8 A
F4-80/200B	16.4 A	9.5 A
F4-80/200A	22.2 A	12.8 A
F4-80/250B	23.4 A	13.5 A
F4-80/250A	25.6 A	14.8 A
F4-100/160B-N	9.0 A	5.2 A
F4-100/160A-N	11.8 A	6.8 A
F4-100/200C	16.4 A	9.5 A
F4-100/200B	21.0 A	12.1 A
F4-100/200A	23.4 A	13.5 A
F4-100/250B	27.5 A	15.9 A
F4-100/250A	34.1 A	19.7 A