



Esecuzione

Elettropompe centrifughe monoblocco con accoppiamento diretto motore-pompa e albero unico fino a 30 kW, costruzione per motori normalizzati IEC con cuscinetto reggispinta integrato da 37 a 75 kW (costruzione Stub-shaft). Corpo pompa con bocca di aspirazione assiale e bocca di mandata radiale in alto, con dimensioni principali e prestazioni secondo EN 733. NM(S): versione con corpo pompa e raccordo in ghisa. B-NM(S): versione con corpo pompa e raccordo/coperchio in bronzo. Le pompe in bronzo vengono fornite completamente verniciate.

Bocche: Flange PN 10, EN 1092-2.

Controflange (a richiesta)

Grandezze	Flange
da NM 32/... a NM 50/...	Flange filettate EN 1092-1, PN 16
da NM 65/... a NMS 100/250	Flange da saldare a sovrapposizione EN 1092-1, PN 10

Impieghi

- Per liquidi puliti senza parti abrasive, non aggressivi per i materiali della pompa (con parti solide fino a 0,2% max).
- Per l'approvvigionamento d'acqua.
- Per impianti di riscaldamento, condizionamento, raffreddamento e circolazione. - Per applicazioni civili e industriali.
- Per impianti antincendio. - Per irrigazione.

Limiti d'impiego

Temperatura liquido: da -10 °C a +90 °C.

Temperatura ambiente fino a 40 °C.

Altezza di aspirazione manometrica fino a 7 m.

Pressione finale massima ammessa nel corpo pompa : 10 bar Servizio continuo.

Motore

Motore ad induzione a 2 poli, 50 Hz (n = 2900 1/min).

NM, NMS: trifase 230/400 V ± 10%, fino a 3 kW;

400/690 V ± 10%, da 4 a 75 kW;

Isolamento classe F. Protezione IP 54.

Classe alta efficienza IE2 per motori trifasi da 0,75 kW.

Esecuzione secondo EN 60034-1; EN 60034-30.

Esecuzioni speciali a richiesta

- Altre tensioni. - Frequenza 60 Hz (vedere catalogo 60 Hz).
- Protezione IP 55. - Tenuta meccanica speciale.
- Tenuta a treccia (solo per esecuzione normale NM).
- Motore monofase (**NMM**) fino a 1,5 kW.
- Esecuzione antideflagrante secondo la direttiva 94/9/CE (ATEX).
- Per liquido o ambiente con temperatura più alta o più bassa.

Materiali

Componenti	NM, NMS	B-NM, B-NMS
Corpo pompa	Ghisa	Bronzo
Raccordo NM	GJL 200 EN 1561	G-Cu Sn 10 EN 1982
Coperchio del corpo per NMS	Ghisa GJL 200 EN 1561	
Raccordo NMS	Ghisa GJL 200 EN 1561	
Girante	Ghisa GJL 200 EN 1561	Bronzo G-Cu Sn 10 EN 1982
	Ottone P- Cu Zn 40 Pb 2 UNI 5705 Per NM,B-NM 32/12-16-20, NM,B-NM 40/20	
Albero	Acciaio AISI 303 fino a 2,2 kW Acciaio AISI 430 da 3 kW a 75 kW	Acciaio al Cr-Ni-Mo AISI 316
Tenuta meccanica	Carbone - ceramica - NBR	
Controflange	Acciaio Fe 430B UNI 7070	

Campo di applicazione n ≈ 2900 1/min

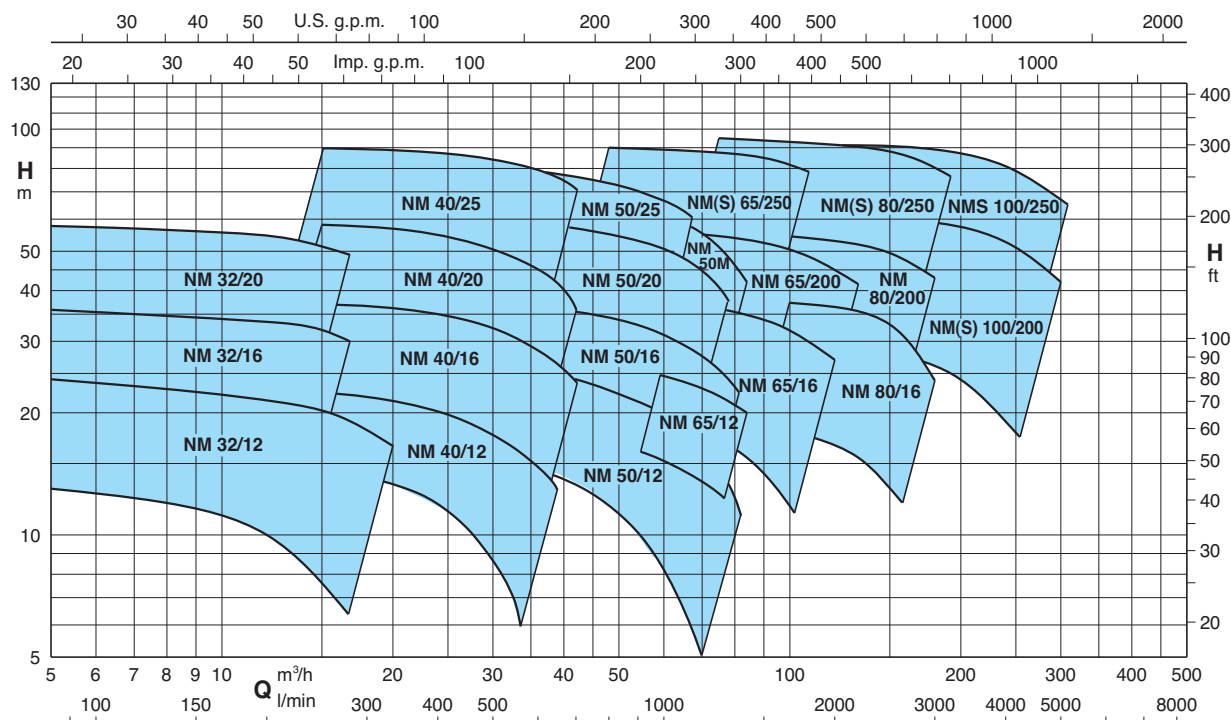

Prestazioni n ≈ 2900 1/min

B-NM	NM	P ₂		Q m ³ /h l/min	6,6	7,5	8,4	9,6	10,8	12	13,2	15	16,8	18,9	21	24	27	30
		kW	HP		110	125	140	160	180	200	220	250	280	315	350	400	450	500
B-NM 32/12F	NM 32/12FE	0,55	0,75	H m	12,5	12,5	12	11,5	11	10	9	7,5						
B-NM 32/12D	NM 32/12DE	0,75	1		18	18	17,5	17	16,5	16	15,5	14						
B-NM 32/12A	NM 32/12AE	1,1	1,5		23	23	22,5	22	21,5	21	20,5	19						
B-NM 32/12S	NM 32/12SE	1,5	2		23,5	23,5	23	22,5	22	21,5	21	20,5						
B-NM 32/16B	NM 32/16BE	1,5	2		29,5	29,5	29	28,5	27,5	27	26	25*	19*	18,5*	16,5*	13*		
B-NM 32/16A/A	NM 32/16A/A	2,2	3		35,5	35,5	35	34,5	34	33,5	33	32*	30*					
B-NM 32/20D/A	NM 32/20D/A	2,2	3		38	37,5	37	36	35	33,5	32							
B-NM 32/20C/A	NM 32/20C/A	3	4		45	44,5	44	43,5	42,5	41	40	38	36*					
B-NM 32/20A/A	NM 32/20A/A	4	5,5		57,5	57	56	55,5	55	54,5	53,5	51,5	49*					

B-NM	NM	P ₂		Q m ³ /h l/min	15	16,8	18,9	21	24	27	30	33	37,8	39	42	45	48	54
		kW	HP		250	280	315	350	400	450	500	550	630	650	700	750	800	900
B-NM 40/12F	NM 40/12F/A	1,1	1,5	H m	14	13,5	13	12	11	9,5	8	6						
B-NM 40/12C	NM 40/12C/A	1,5	2		17,5	17	16,5	16	15	13,5	12	10,5	7,5	6,5				
B-NM 40/12A/A	NM 40/12A/B	2,2	3		22	22	21,5	21	20	19	18	16,5	14	13	11,5			
B-NM 40/16C/A	NM 40/16C/B	2,2	3		23	22,5	22	21,5	20	18,5	16,5	14,5	11	10				
B-NM 40/16B/A	NM 40/16B/B	3	4		29	28,8	28	27,5	26,5	25	23,5	21,5	18	17	14			
B-NM 40/16A/A	NM 40/16A/B	4	5,5		37	36,5	36,5	36	35	33,5	32	30,5	27	26	23,5	20	17	
B-NM 40/20D/A	NM 40/20D/A	4	5,5		39	38	37	35,5	33,5	30,5	27	22,5	14					
B-NM 40/20C/A	NM 40/20C/A	4	5,5		41,5	40,5	39,5	38	36	33,5								
B-NM 40/200B/A	NM 40/200B/A	5,5	7,5		50	49,5	48,5	47,5	45,5	43,5	41,5	37,5	30,5					
	NM 40/20AR/A	5,5	7,5		55	54,5	54	53	51	49								
B-NM 40/200A/A	NM 40/20A/A	7,5	10		57,5	57	56,5	55,5	54,5	52,5	50,5	48	42,5	40,5	35			
B-NM 4025/C/B	NM 40/25C/B	9,2	12,5		61	61	60,5	59,5	58,5	56,5	53,5	49,5	41,5	40	33,5			
B-NM 4025/B/B	NM 40/25B/B	11	15		69,5	69,5	69	68,5	67	65,5	63,5	60,5	53,5	51	45			
B-NM 4025A/B	NM 40/25A/B	15	20		90	90	89,5	89	88,5	87	85	83	77,5	76	70,5			

B-NM	NM	P ₂		Q m ³ /h l/min	24	27	30	33	37,8	42	48	54	60	66	69	72	75	78	81	84	
		kW	HP		400	450	500	550	630	700	800	900	1000	1100	1150	1200	1250	1300	1350	1400	
B-NM 50/12F/A	NM 50/12F/B	2,2	3	H m			15,5	15	14	13,5	12	10	8	6							
B-NM 50/12D/A	NM 50/12D/B	3	4				20	19,5	18,5	18	16,5	14,5	13	10,5	9	8					
B-NM 50/12A/A	NM 50/12A/B	4	5,5				24	24	23	22,5	21	19,5	17,5	15	14	12,5	11,5	10			
B-NM 50/12S/A	NM 50/12S/B	4	5,5				26,5	26	25,5	24,5	23,5	22	20	18	16,5	15,5	14	13	11		
B-NM 50/160B/B	NM 50/16B/B	5,5	7,5				31	30,5	29,5	28	26	24	21,5	19	17,5	15,5	13,5	11,5	9,5		
B-NM 50/160A/B	NM 50/16A/B	7,5	10				38,5	38	37,5	36,5	34,5	32,5	30	27	25,5	24	22,5	20,5	19		
B-NM 50/200B/B	NM 50/20B/B	9,2	12,5		48	47,5	47,5	47	45,5	44,5	42,5	40	37	33	30,5	28	25,5	23			
B-NM 50/200A/B	NM 50/20A/B	11	15		55	55	54,5	54,5	53,5	52	50	48	45	41,5	39,5	37	35	32,5			
B-NM 50/200S/B	NM 50/20S/B	15	20		60	60	59,5	59,5	58,5	57,5	55,5	53,5	50,5	47	45	43	40,5	37			
B-NM 5025/C/B	NM 50/25C/B	11	15		55	54,5	54	53	51,5	49,5	46	41,5	35,5	28,5	24,5						
B-NM 5025/B/B	NM 50/25B/B	15	20		69	68,5	68	67,5	66	64	61	57	52,5	46,5	43						
B-NM 5025A/B	NM 50/25A/B	18,5	25		80,5	80,5	80	79,5	78,5	77	74,5	71,5	67	61,5	58,5						
B-NM 5025/65E/A	NM 50M/E/A	11	15				48	47,5	47	46	45	43	40	37	32	29,5	27	24			
B-NM 5025/65D/A	NM 50M/D/A	15	20				57	56,5	56	55	53	51	48	44,5	42	39,5	37	32	29	25*	
B-NM 5025/65C/A	NM 50M/C/A	18,5	25				68	67,5	67	66,5	65	63	61	58	56	53,5	51,5	48	45,5	42*	

B-NM - B-NMS	NM - NMS	P ₂		Q m ³ /h l/min	37,8	42	48	54	60	66	75	84	96	108	120	132	150	168
		kW	HP		630	700	800	900	1000	1100	1250	1400	1600	1800	2000	2200	2500	2800
	NM 65/12E/A	4	5,5	H m	18	17,5	17	16,5	16	15	13,5*							
B-NM 65/125C/A	NM 65/12C/A	5,5	7,5		22	21,5	21	20,5	20	19,5	18	15,5*						
B-NM 65/125A/A	NM 65/12A/A	7,5	10		26	25,5	25	24,5	24	23,5	22	20*						
B-NM 65/160E/A	NM 65/16E/A	5,5	7,5				20	19,5	19	18,5	17	15,5	13*	10*				
B-NM 65/160D/A	NM 65/16D/A	7,5	10				26	25,5	25	24,5	23,5	22	20*	16,5*	13*			
B-NM 65/160C/A	NM 65/16C/A	9,2	12,5				30	29,5	29	28,5	28	26,5	24,5*	21,5*	18*			
B-NM 65/160B/A	NM 65/16B/A	11	15				33,5	33	32,5	32	31	30	28*	25,5*	22*			
B-NM 65/160A/A	NM 65/16A/A	15	20				38	37,5	37	36,5	36	35	33*	30,5*	27*			
B-NM 65/200C/A	NM 65/20C/A	15	20				44	43,5	43	42,5	41	39,5	37,5*	35*	31*	27*		
B-NM 65/200B/A	NM 65/20B/A	18,5	25				50	49,5	49	48,5	47,5	46,5	44,5*	42*	39*	35*		
B-NM 65/200A/A	NM 65/200A/A	22	30				56,5	56	55,5	55	54,5	53,5	51*	48,5*	45,5*	41,5*		
B-NM 65/250C/A	NM 65/250C/A	22	30				64	63,5	63	61,5*	60*	57,5*	54,5*	50*				
B-NM 65/250B/A	NM 65/250B/A	30	40				79,5	79	78,5	78*	77*	75*	72*	67*				
B-NMS 65/250A	NMS 65/250A	37	50				90	89,5	89	88,5*	87,5*	86*	83,5*	78,5*				

Prestazioni n ≈ 2900 1/min

B-NM - B-NMS	NM - NMS	P ₂		Q m ³ /h l/min	75	84	96	108	120	132	150	168	180	192	210	240	270	300
		kW	HP															
B-NM 80/160E/A	NM 80/16E/A	7,5	10	20	19,3	18,5	17,5*	16,5*	15,5*	13*								
B-NM 80/160D/A	NM 80/16D/A	9,2	12,5	23	22,5	22	21*	19,5*	18*	15*								
B-NM 80/160C/A	NM 80/16C/A	11	15	27,5	27	26,5	25,5*	24,5*	23*	20*	16*							
B-NM 80/160B/A	NM 80/16B/A	15	20	34	33,5	33	32,5*	32*	31*	28*	23*	18*						
B-NM 80/160A/A	NM 80/16A/A	18,5	25	38,5	38	37,5	37*	36,5*	36*	33*	29*	24*						
B-NMS 80/200B	NM 80/200B/A	22	30	46,5	46	45,5	44,5	43,5*	42*	39*	35,5*	32*						
B-NMS 80/200A	NM 80/200A/A	30	40	56	55,5	55	54	53*	52*	49,5*	46*	43*						
B-NMS 80/250E	NM 80/250E/A	22	30	51	50	48,5	46,5	44,5*	42*	38*	33*	29*						
B-NMS 80/250D	NM 80/250D/A	30	40	65	64	62,5	61	59*	56,5*	53*	49*	45,5*	41*					
B-NMS 80/250C	NMS 80/250C	37	50	73,5	73	72	70,5	69*	67*	63*	59*	55,5*	51,5*					
B-NMS 80/250B	NMS 80/250B	45	60	84	83,5	82,5	81,5	80*	78*	74,5*	70,5*	67*	63*					
B-NMS 80/250A	NMS 80/250A	55	75	95	94,5	93,5	92,5	91,5*	90*	87,5*	84*	80,5*	76,5*					
B-NMS 100/200E	NM 100/200E/A	18,5	25				30	29,5	29	28	27	26*	25*	23*	19*			
B-NMS 100/200D	NM 100/200D/A	22	30				36	35,5	35	34	33	32*	31*	29*	24,5*	19*		
B-NMS 100/200C	NM 100/200C/A	30	40				45	44,5	44	43,5	42,5	41,5*	40,5*	39*	34,5*	29*		
B-NMS 100/200B	NMS 100/200B	37	50				54	53,5	53	52,5	51,5	50,5*	49,5*	48*	44*	38,5*	32°	
B-NMS 100/200A	NMS 100/200A	45	60				61,5	61	60,5	60	59,5	58,5*	58*	56,5*	53*	48*	42°	
B-NMS 100/250B	NMS 100/250B	55	75				73,5	73	72,5	71,5	70	68,5*	67*	65*	61*	55,5*	48,5°	
B-NMS 100/250A	NMS 100/250A	75	100				91	90,5	90	89,5	88,5	88*	87*	85*	81*	75*	67°	

NM(S) Esecuzione normale.
B-NM(S) Esecuzione in bronzo.

P₂ Potenza nominale motore.
H Prevalenza totale in m.

* Massima altezza di aspirazione manometrica 1-2 m.
◦ Con battente positivo di 1 m.
Tolleranze secondo ISO 9906, allegato A.

Correnti nominali

P ₂		230V Δ / 400V Y 400V Δ / 690V Y			IA/IN
kW	HP	IN A	IN A	IN A	
0,55	0,75	3	1,7		4,3
0,75	1	3,3	1,9		5,8
1,1	1,5	4,7	2,7		5,6
1,5	2	7,5	4,3		5,5
2,2	3	9,2	5,3		7,4
3	4	11,5	6,6		8,2
4	5,5		9,6	5,5	7,6
5,5	7,5		10,9	6,3	9,1
7,5	10		14,3	8,3	9,1
9,2	12,5		18,5	10,7	8,2
11	15		21,5	12,4	8,5
15	20		27,3	15,8	9,5
18,5	25		34	19,6	9,4
22	30		41	23,7	10,7
30	40		54	31,2	8,8
37	50		64	36,9	7,2
45	60		77	44,5	7,3
55	75		93	53,7	6,8
75	100		128	73,9	7

P₂ Potenza nominale motore.
IA/IN Corrente di spunto / Corrente nominale.

Curve caratteristiche $n \approx 2900$ 1/min

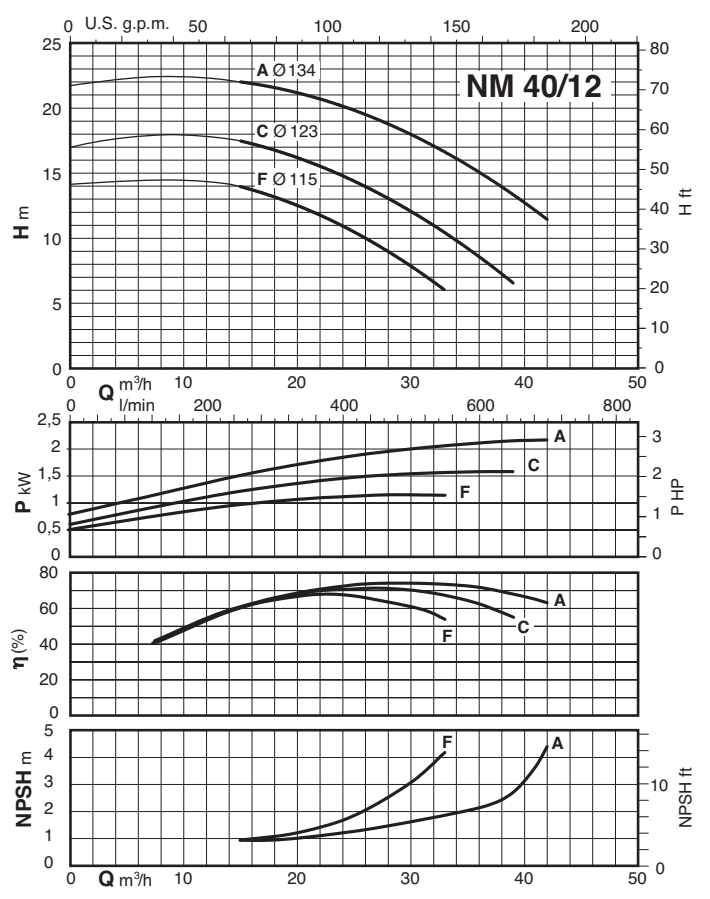
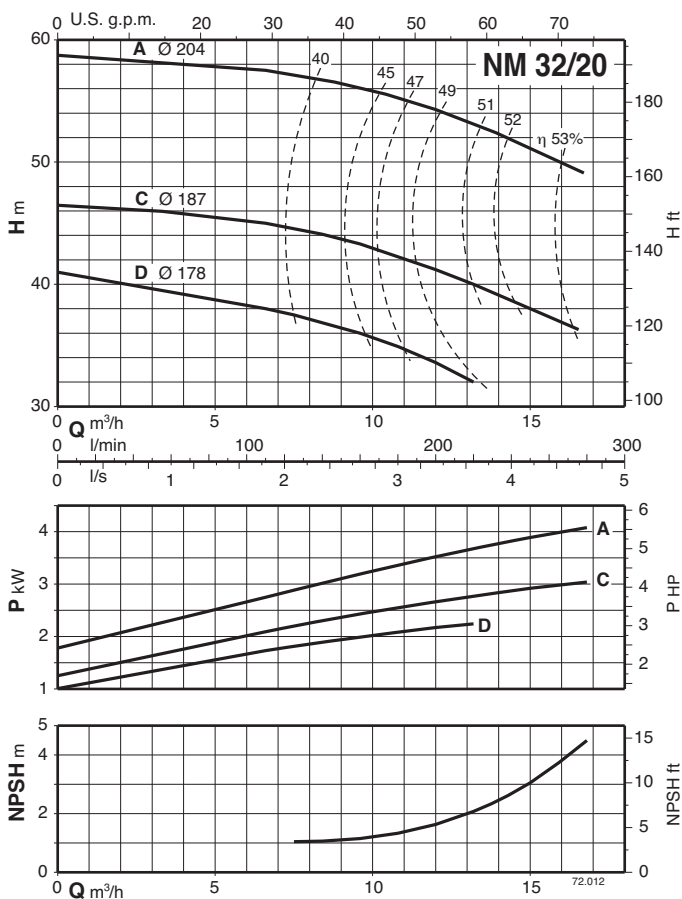
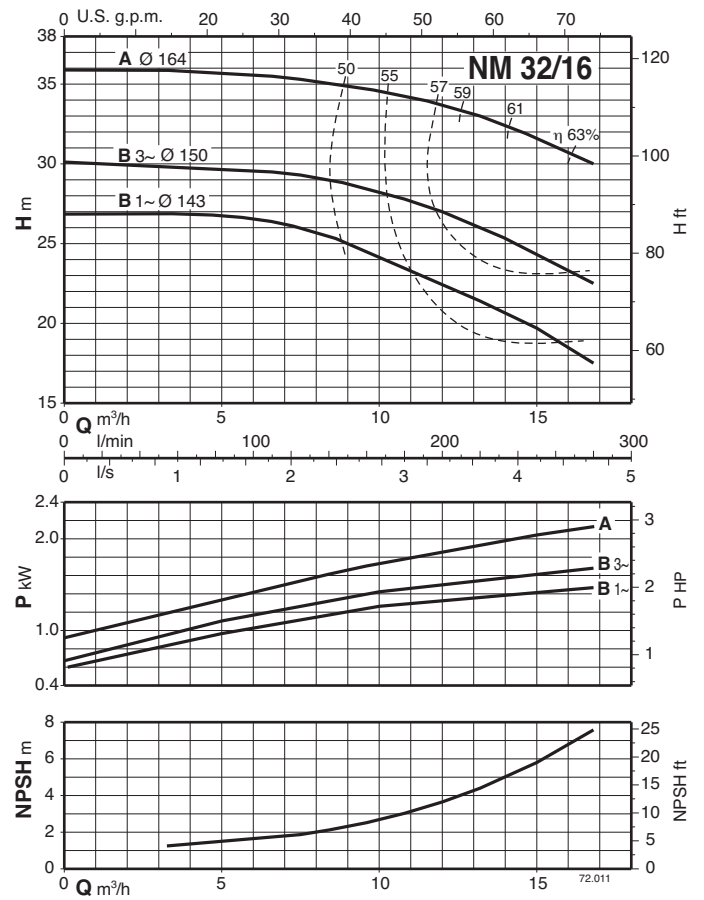
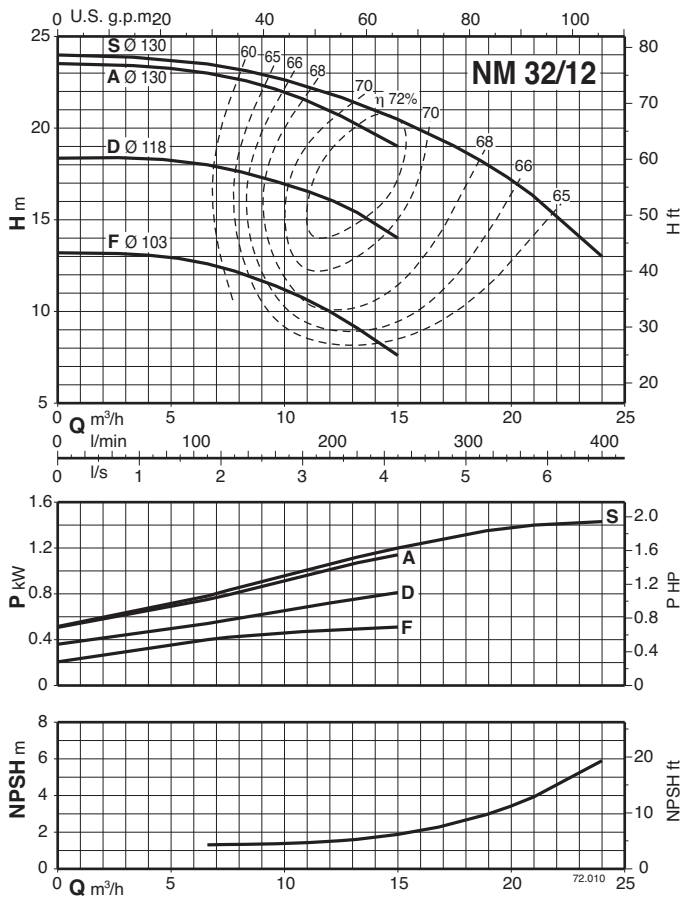

Curve caratteristiche $n \approx 2900$ 1/min

2

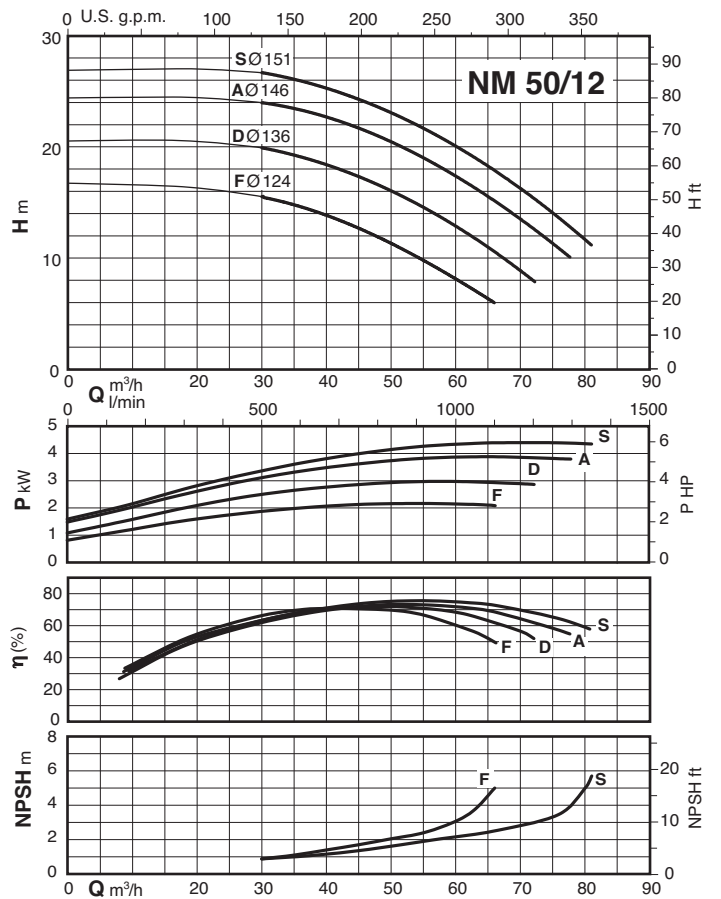
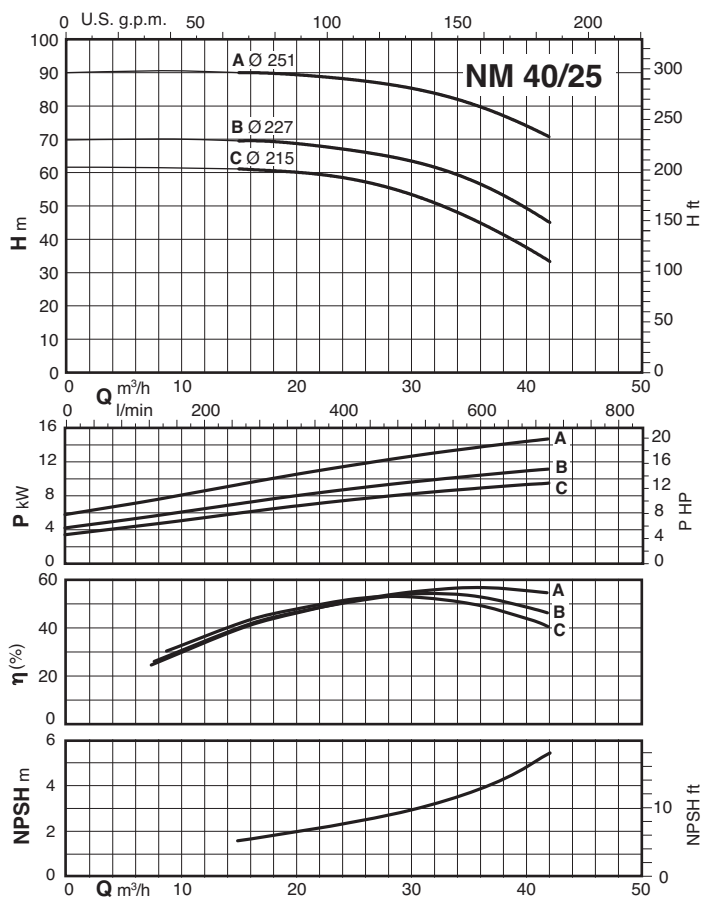
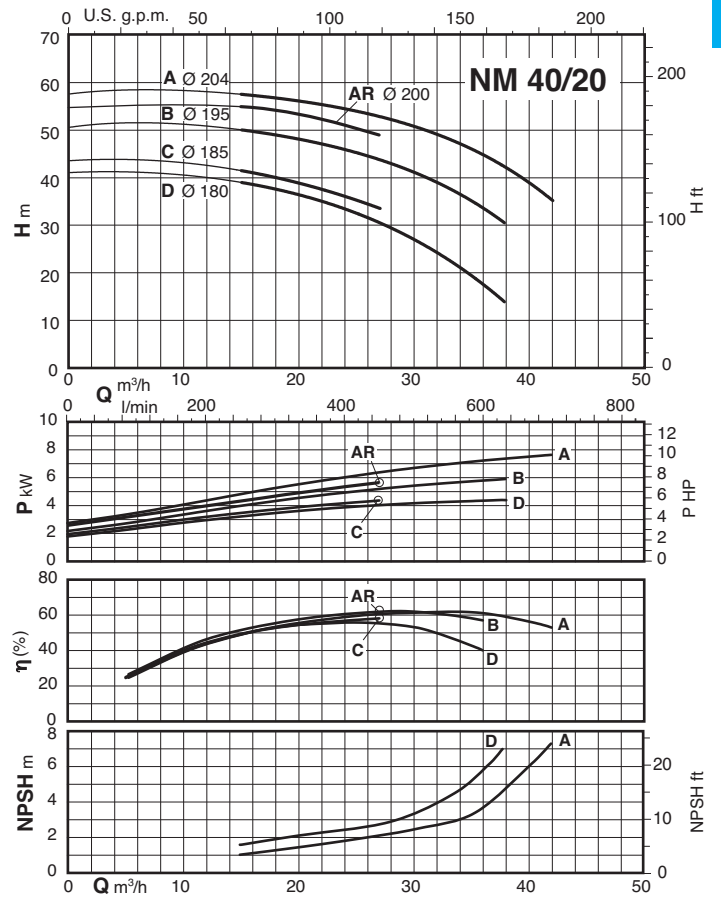
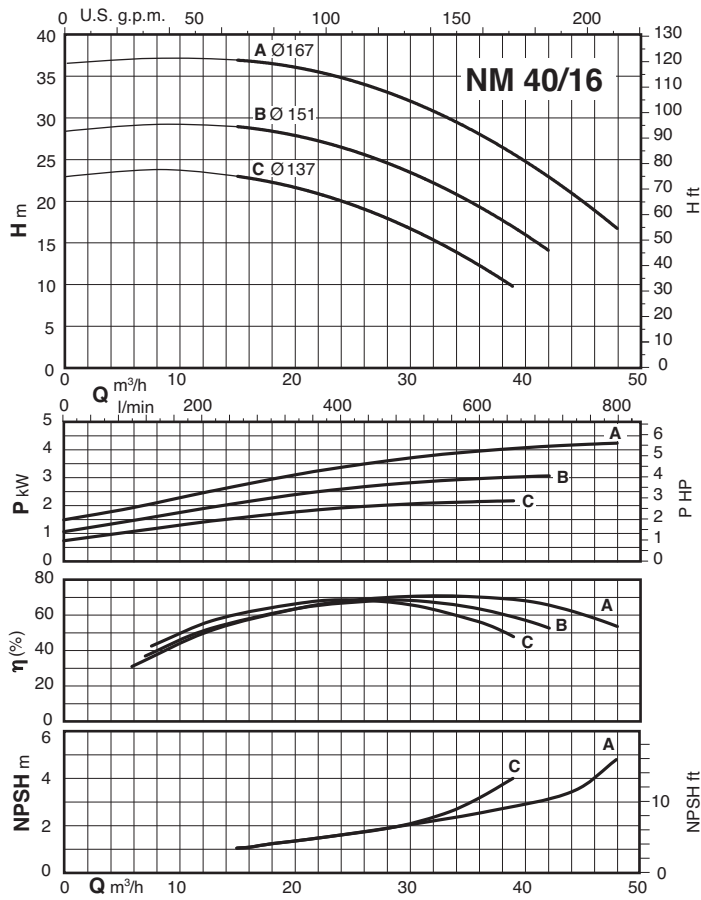

Curve caratteristiche $n \approx 2900$ 1/min

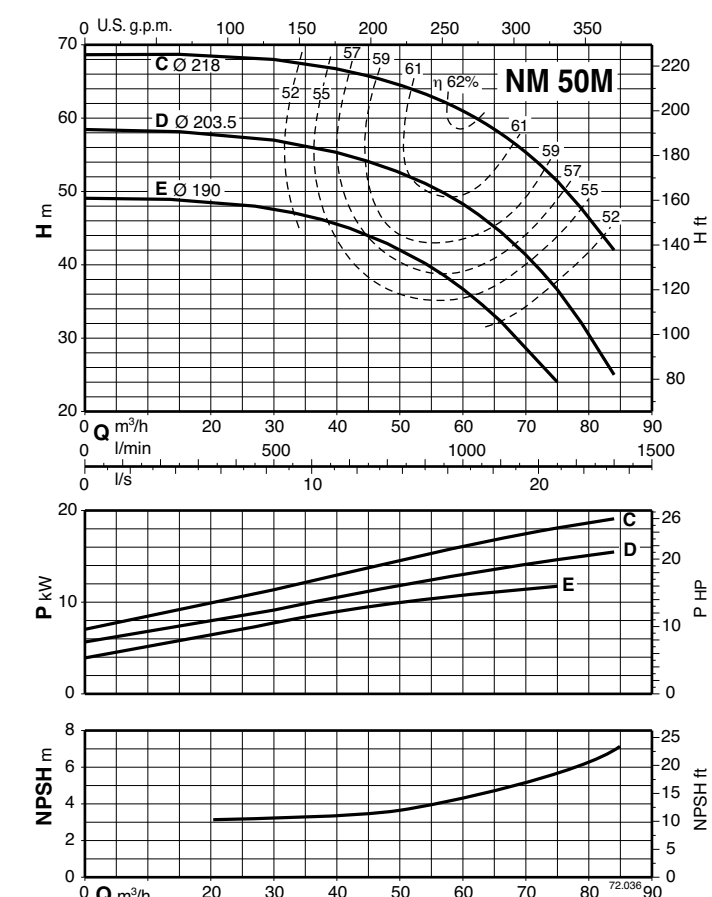
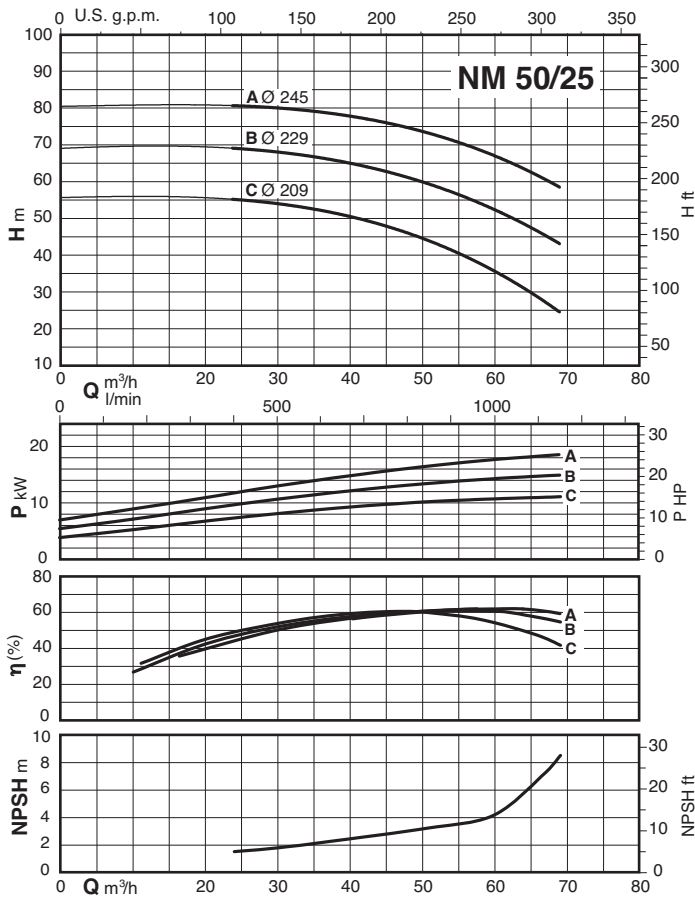
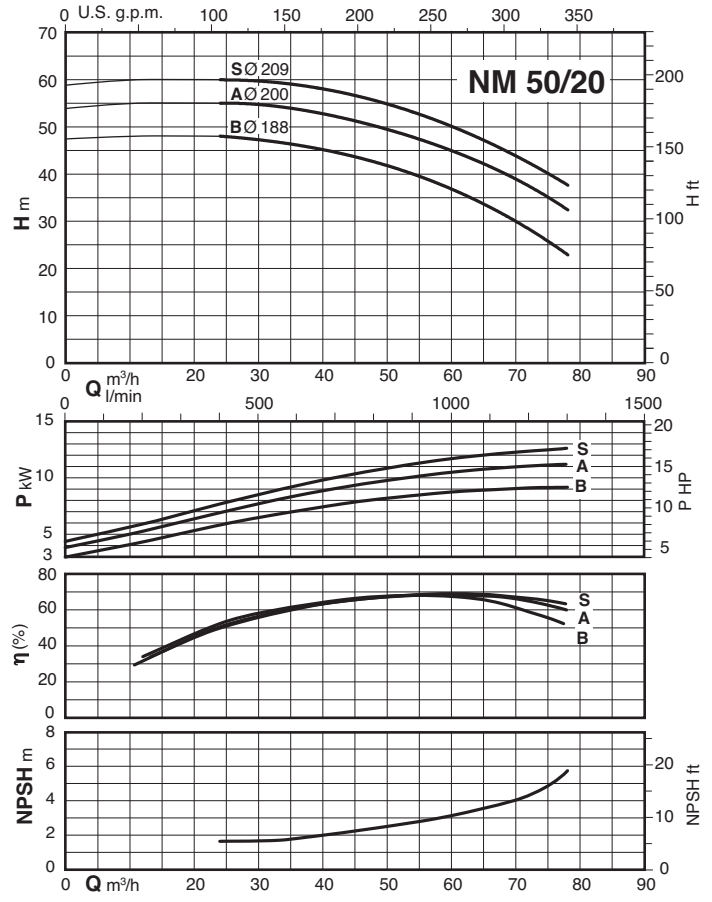
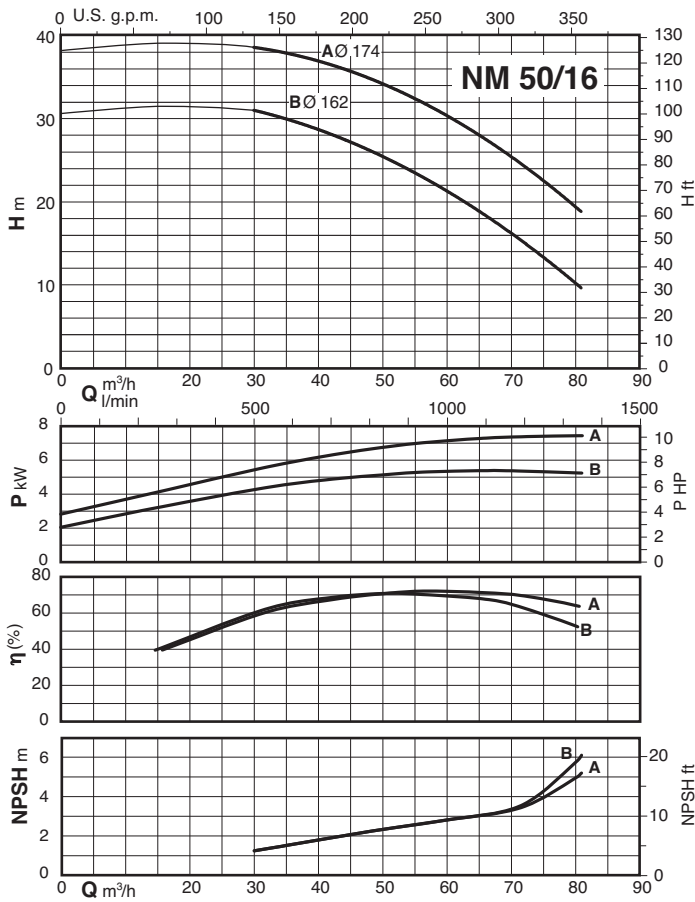

Curve caratteristiche $n \approx 2900$ 1/min

2

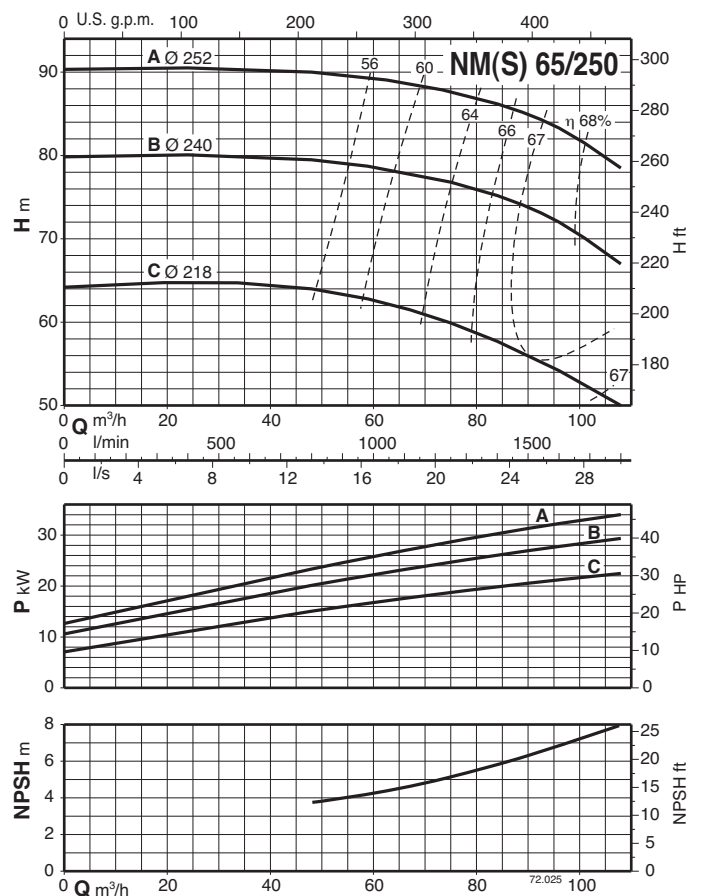
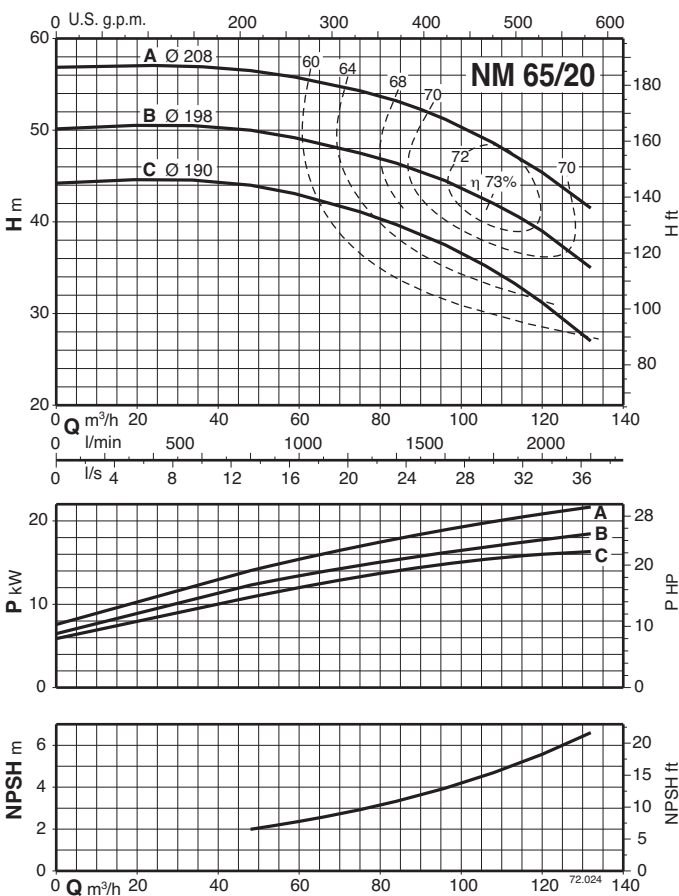
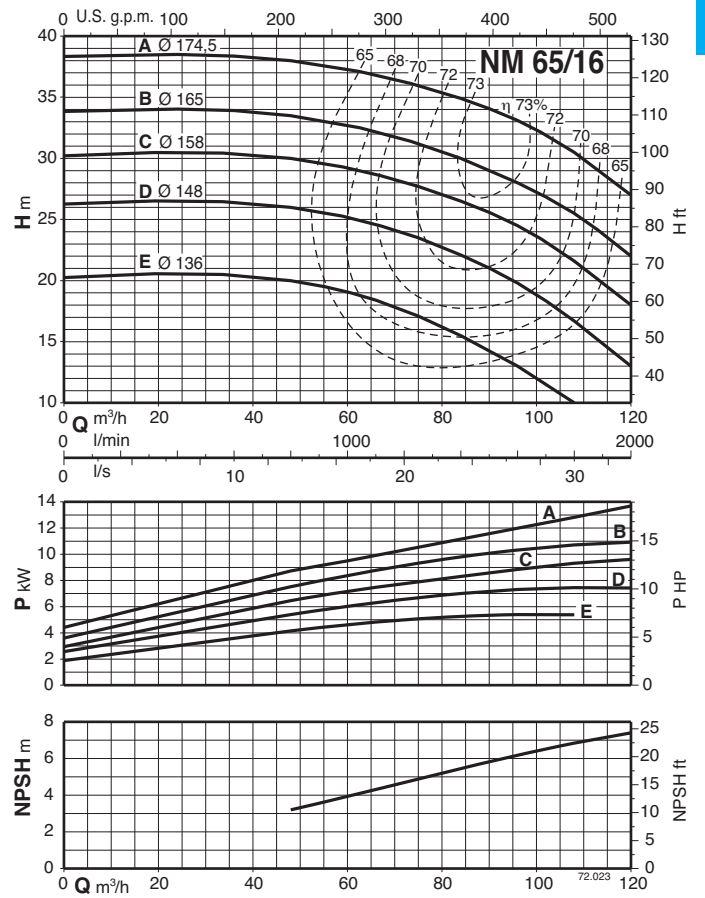
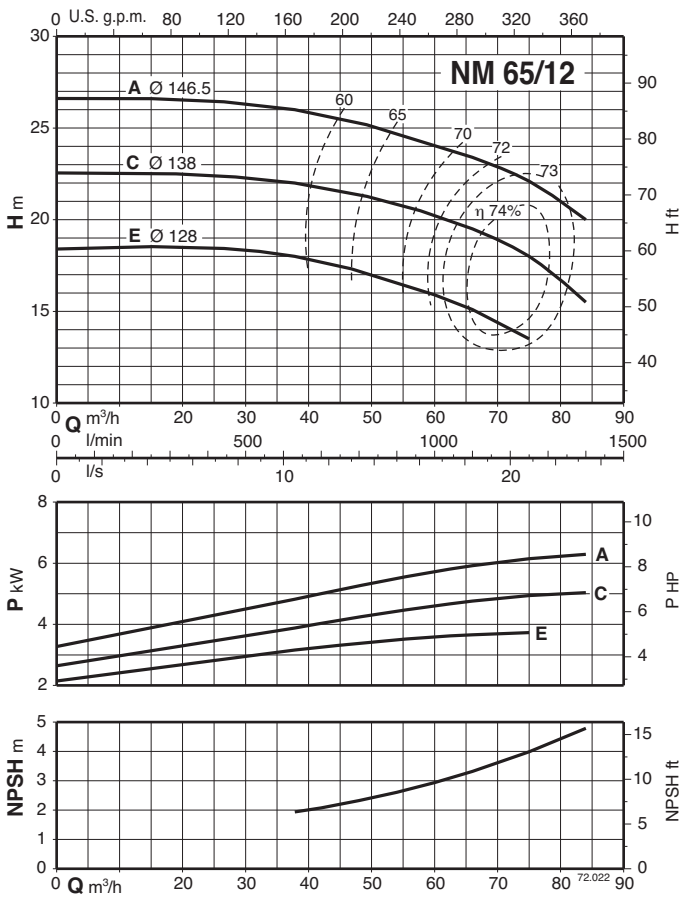

Curve caratteristiche n ≈ 2900 1/min

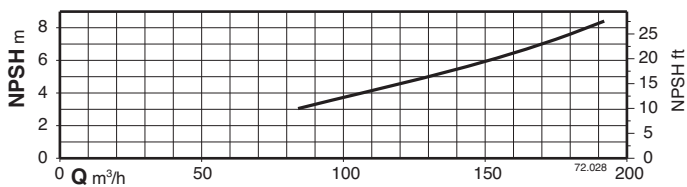
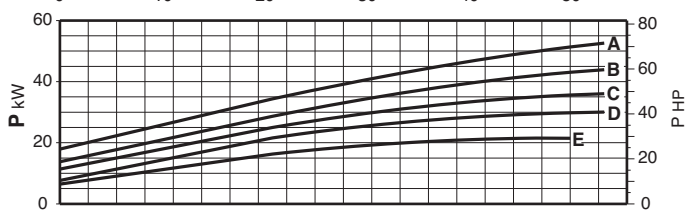
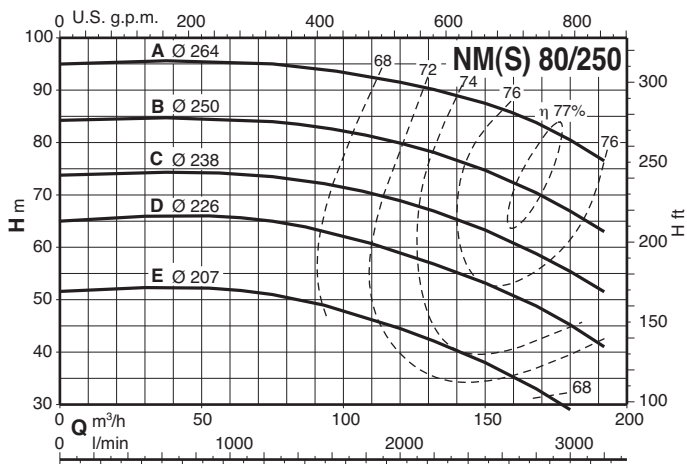
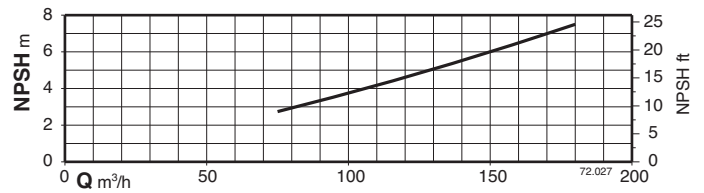
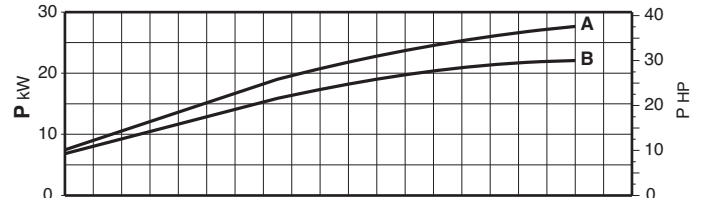
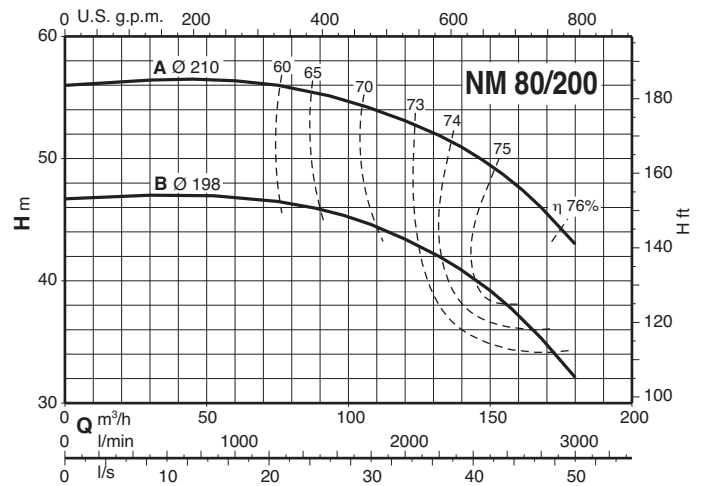
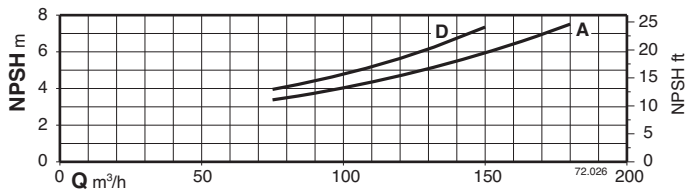
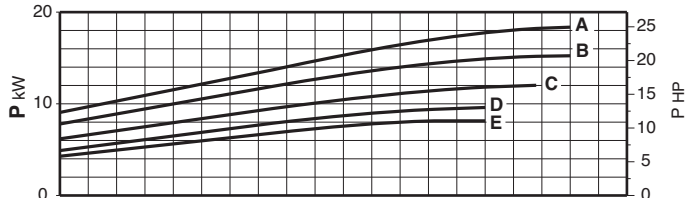
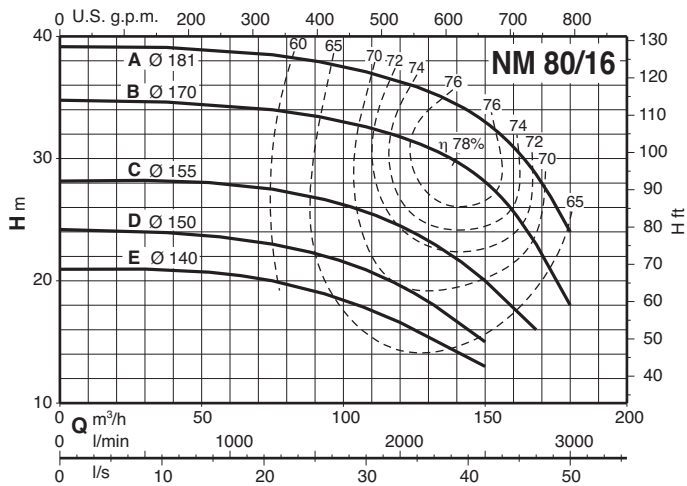

Curve caratteristiche $n \approx 2900$ 1/min

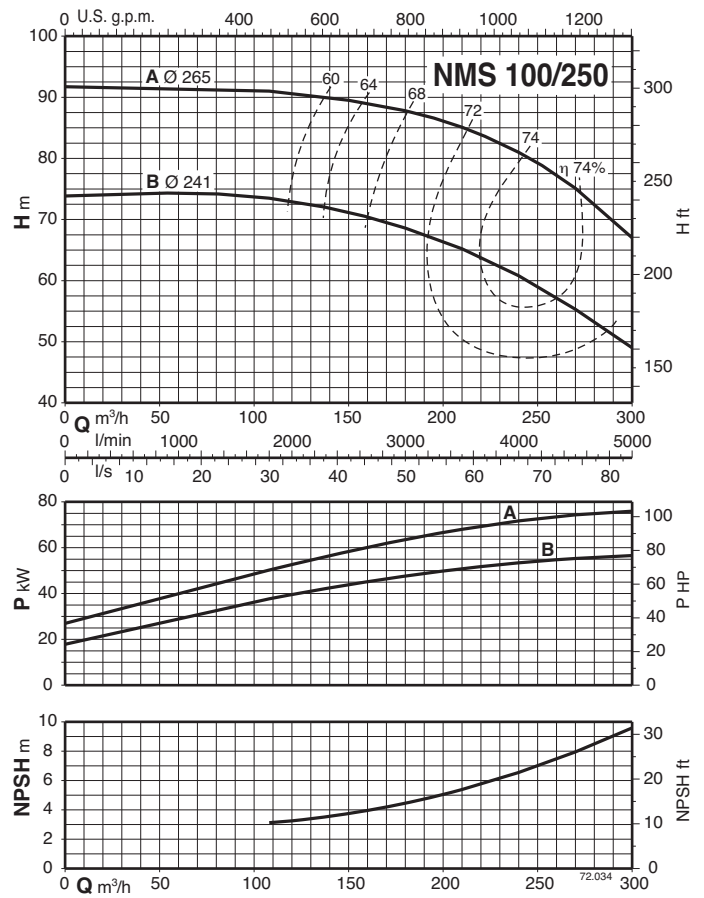
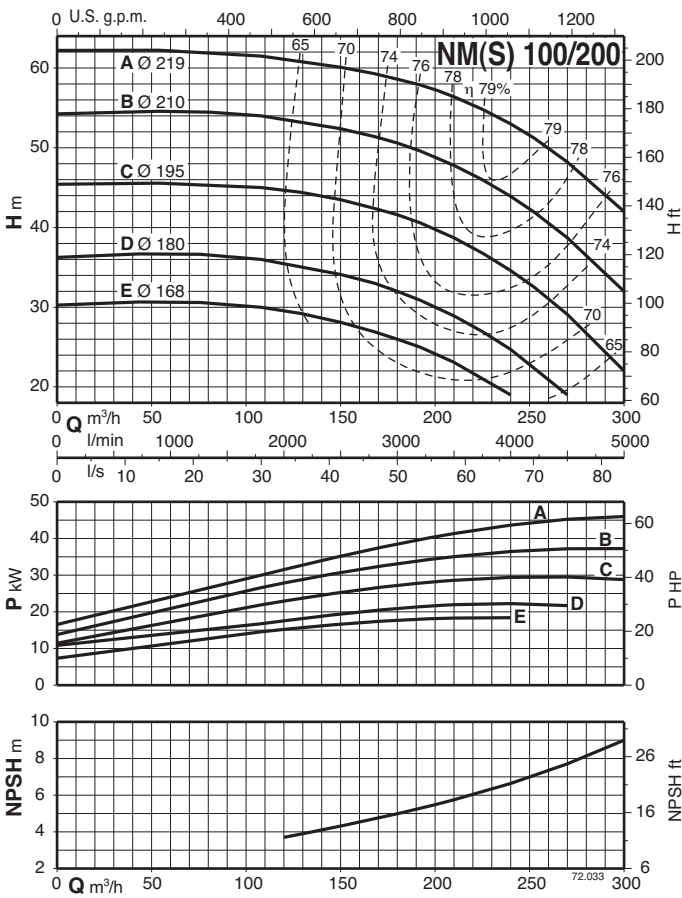

Dimensioni e pesi



Figura	NM	mm																			kg	
		DN1	DN2	a	f	h1	h2	h3	m1	m2	n1	n2	n3	z	b	s	l1	l2	w	g1		
1	NM 32/12SE-AE-DE-FE	50	32	80	405	112	140	240	100	70	190	140	37	-	50	14	93	97	245	12	27-25-24-24	
	NM 32/16BE NM 32/16A/A	50	32	80	410 450	132	160	260	100	70	240	190	47	-	50	14	120	120	250 290	12	34 39	
	NM 32/20D/A NM 32/20C/A NM 32/20A/A	50	32	80	450 475 475	160	180	288 298 298	100	70	240	190	62 60 60	-	50	14	140	140	290 295 295	12	42 52 52,5	
	NM 40/12C/A-F/A NM 40/12A/B	65	40	80	410 450	112	140	240	100	70	210	160	37	-	50	14	100	113	250 290	12	29-27 34	
	NM 40/16C/B NM 40/16B/B NM 40/16A/B	65	40	80	450 475 475	132	160	260 270 270	100	70	240	190	47 45 45	-	50	14	119	119	290 295 295	12	39 48 49,5	
	NM 40/20C/A-D/A NM 40/20A/A-AR/A-B/A	65	40	100	495 525	160	180	298 320	100	70	265	212	60 49	-	50	14	140	140	295 320	12	55,5-55,5 72,5-66-66	
	NM 40/25B/B-C/B NM 40/25A/B	65	40	100	640 715	180	225	365	125	95	320	250	50	-	65	14	175	175	410 460	15	116-110 145,5	
	NM 50/12F/B NM 50/12D/B NM 50/12A/B-S/B	65	50	100	470 495 495	132	160	260 270 270	100	70	240	190	47 45 45	-	50	14	121	137	290 295 295	12	41 50 51,5-51,5	
	NM 50/16A/B-B/B	65	50	100	525	160	180	320	100	70	265	212	49	-	50	14	127	141	320	14	70,5-64	
	NM 50/20A/B-B/B NM 50/20S/B	65	50	100	640 720	160	200	345	100	70	265	212	40	-	50	14	140	153	410 460	15	106-100 124,5	
	NM 50/25C/B NM 50/25B/B NM 50/25A/B	65	50	100	645 720 720	180	225	365	125	95	320	250	50	-	65	14	175	175	415 465 465	15	126 144,5 153	
	NM 50M/E/A NM 50M/D/A NM 50M/C/A	65	50	100	700 750 775	192	225	377	298	258	262	216	-	20	69	12	175	175	239	6*	135 151 165	
	NM 65/12E/A NM 65/12A/A-C/A	80	65	100	495 525	160	180	298 320	125	95	280	212	60 49	-	65	14	134	156	295 320	15	55,5 73,5-68	
	NM 65/16D/A-E/A NM 65/16B/A-C/A NM 65/16A/A	80	65	100	525 640 715	160	200	320 345 345	125	95	280	212	49 40 40	-	65	14	150	172	320 410 460	15	75-70 106-100 133,5	
	NM 65/20C/A NM 65/20B/A	80	65	100	715	180	225	365	125	95	320	250	50	-	65	14	155	175	460	15	139,5 145	
	4	NM 65/200A/A	80	65	100	825	202	225	408	400	360	344	254	-	20	90	14	155	175	245	42*	185
		NM 65/250B/A-C/A	80	65	100	825	202	250	408	400	360	344	254	-	20	90	14	175	190	245	42*	201-195
	1	NM 80/16E/A NM 80/16C/A-D/A NM 80/16B/A NM 80/16A/A	100	80	125	545 670 745 745	180	225	340 365 365 365	125	95	320	250	60 50 50 50	-	65	14	165	193	320 415 465 465	15	83,5 113-108 142,5 150
		NM 80/200A/A-B/A	100	80	125	850	202	250	408	400	360	344	254	-	20	90	14	170	194	245	42*	200-194
		NM 80/250D/A-E/A	100	80	125	850	202	280	408	400	360	344	254	-	20	90	14	191	210	245	42*	209-203
NM 100/200E/A NM 100/200C/A-D/A		125	100	125	800 850	192 202	280	377 408	298 400	258 360	262 344	216 254	-	20	69 90	12 14	180	212	239 245	6 42*	179 201-195	

Flange EN 1092-2

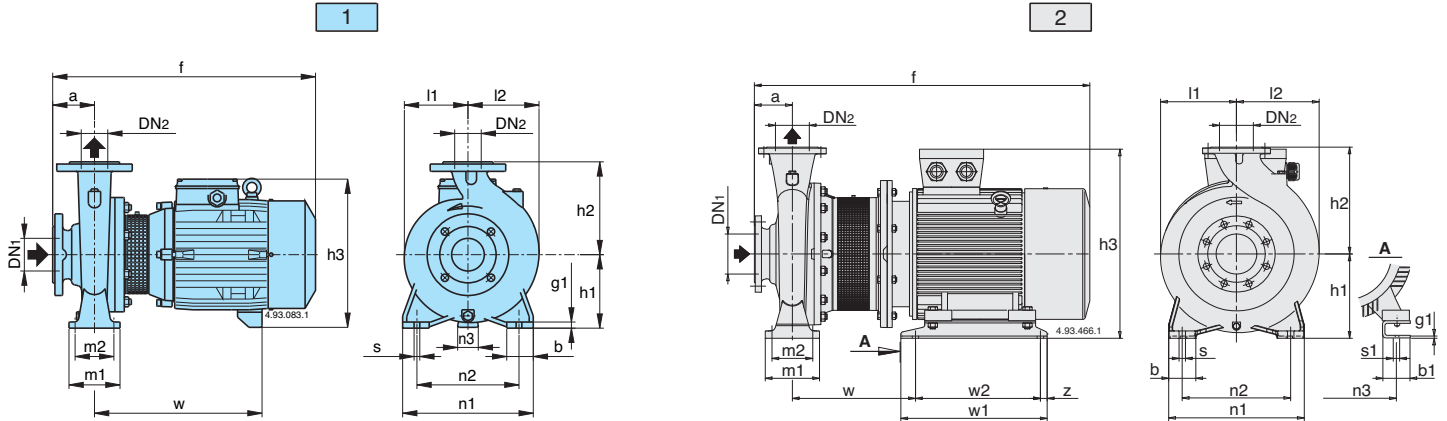
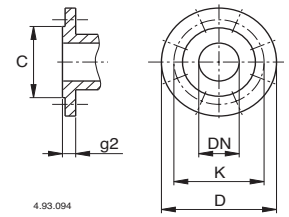

DN	mm				
	C	K	D	Fori	g2
				N° Ø	
32	76	100	140	4 19	18
40	84	110	150	4 19	18
50	99	125	165	4 19	20
65	118	145	185	4 19	20
80	132	160	200	8 19	22
100	156	180	220	8 19	24
125	184	210	250	8 19	24

Figura	NMS	mm																				kg	
		DN1	DN2	a	f1	f	h1	h2	h3	m1	m2	n1	n2	n3	b	b1	s	s1	l1	l2	w		w1
2	NMS 65/250A	80	65	100	373	1032	200	250	505	160	120	360	280	318	80	83	18	19	175	190	406	355	305
	NMS 80/250C	100	80	125	398	1057	200	280	505	160	120	400	315	318	80	83	18	19	200	210	406	355	305
	NMS 80/250B	100	80	125	421	1130	225	280	550	160	120	410	315	356	80	80	18	19	225	225	445	361	286
	NMS 80/250A	100	80	125	451	1198	250	280	642	160	120	410	315	406	80	100	18	24	275	275	619	409	349
	NMS 100/200B	125	100	125	398	1057	200	280	505	160	120	360	280	318	80	83	18	19	200	212	406	355	305
	NMS 100/200A	125	100	125	421	1130	250	280	550	160	120	410	315	356	80	80	18	19	225	225	445	361	286
	NMS 100/250B	125	100	125	466	1213	250	280	642	160	120	410	315	406	80	100	18	24	275	275	494	409	349
	NMS 100/250A	125	100	125	466	1286	280	280	712	160	120	410	315	457	80	100	18	24	275	275	516	479	368

Pompe con tenuta a treccia, dimensioni a richiesta.

Dimensioni e pesi



Figura	B- NM	mm																		kg	
		DN1	DN2	a	f	h1	h2	h3	m1	m2	n1	n2	n3	z	b	s	l1	l2	w	g1	B-NM
1	B-NM 32/12S-A-D-F	50	32	80	405	112	140	240	100	70	190	140	37	-	50	14	93	97	245	12	33-32-31-29
	B-NM 32/16B	50	32	80	410	132	160	260	100	70	240	190	47	-	50	14	120	120	250	12	44
	B-NM 32/16A/A	50	32	80	450	132	160	260	100	70	240	190	47	-	50	14	120	120	290	12	48
	B-NM 32/20D/A	50	32	80	450	160	180	288	100	70	240	190	45	-	50	14	140	140	290	12	52
	B-NM 32/20C/A	50	32	80	475	160	180	298	100	70	240	190	60	-	50	14	140	140	295	12	60
	B-NM 32/20A/A	50	32	80	475	160	180	298	100	70	240	190	60	-	50	14	140	140	295	12	61,5
3	B-NM 40/12C-F	65	40	80	410	112	140	240	100	70	210	160	37	-	50	14	100	113	250	12	35-33
	B-NM 40/12A/A	65	40	80	450	112	140	240	100	70	210	160	37	-	50	14	100	113	290	12	40
4	B-NM 40/16C/A	65	40	80	450	132	160	260	100	70	240	190	47	-	50	14	119	119	290	12	48
	B-NM 40/16B/A	65	40	80	475	132	160	270	100	70	240	190	45	-	50	14	119	119	295	12	56
	B-NM 40/16A/A	65	40	80	475	132	160	270	100	70	240	190	45	-	50	14	119	119	295	12	57,5
3	B-NM 40/20C/A-D/A	65	40	100	495	160	180	298	100	70	265	212	60	-	50	14	140	140	295	12	63,5-62,5
	B-NM 40/200A/A-B/A	65	40	100	580	160	180	320	100	70	265	212	49	-	50	14	140	140	375	12	80,5-75
4	B-NM 4025/B/B-C/B	65	40	100	635	192	225	377	298	258	262	216	-	20	69	12	175	175	174	6	130-124
	B-NM 4025/A/B	65	40	100	705	192	225	377	298	258	262	216	-	20	69	12	175	175	174	6	159,5
1	B-NM 50/12F/A	65	50	100	470	132	160	260	100	70	240	190	47	-	50	14	121	137	290	12	52
	B-NM 50/12D/A	65	50	100	495	132	160	270	100	70	240	190	45	-	50	14	121	137	295	12	61
	B-NM 50/12A/A-S/A	65	50	100	495	132	160	270	100	70	240	190	45	-	50	14	121	137	295	12	63,5-63,5
3	B-NM 50/160A/B-B/B	65	50	100	580	160	180	320	100	70	265	212	49	-	50	14	127	141	375	14	80,5-74,5
4	B-NM 50/200A/B-B/B	65	50	100	695	192	200	377	298	258	262	216	-	20	69	12	140	153	234	6	128-121
	B-NM 50/200S/B	65	50	100	720	192	200	377	298	258	262	216	-	20	69	12	140	153	234	6	140,5
	B-NM 5025/C/B	65	50	100	635	192	225	377	298	258	262	216	-	20	69	12	175	175	174	6	135
	B-NM 5025/B/B	65	50	100	710	192	225	377	298	258	262	216	-	20	69	12	175	175	174	6	144
4	B-NM 5025/A/B	65	50	100	710	192	225	377	298	258	262	216	-	20	69	12	175	175	174	6	161
	B-NM 5025/65E/A	65	50	100	635	192	225	377	298	258	262	216	-	20	69	12	175	175	174	6	135
	B-NM 5025/65D/A	65	50	100	710	192	225	377	298	258	262	216	-	20	69	12	175	175	174	6	156,5
3	B-NM 5025/65C/A	65	50	100	710	192	225	377	298	258	262	216	-	20	69	12	175	175	174	6	161
	B-NM 65/125A/A-C/A	80	65	100	580	160	180	320	125	95	280	212	49	-	65	14	134	156	375	15	93,5-73
	B-NM 65/160D/A-E/A	80	65	100	575	160	200	320	125	95	280	212	49	-	65	14	150	172	375	15	83,5-79
4	B-NM 65/160C/A	80	65	100	660	160	200	345	125	95	280	212	40	-	65	14	150	172	430	15	108
	B-NM 65/160B/A	80	65	100	695	192	200	377	298	258	262	216	-	20	69	12	150	172	234	6	149
	B-NM 65/160A/A	80	65	100	770	192	200	377	298	258	262	216	-	20	69	12	150	172	234	6	178,5
4	B-NM 65/200B/A-C/A	80	65	100	775	192	225	377	298	258	262	216	-	20	69	12	155	175	239	6	183-169,5
	B-NM 65/200A/A	80	65	100	825	202	250	408	400	360	344	254	-	20	90	14	175	190	245	42*	200
3	B-NM 65/250B/A-C/A	80	65	100	825	202	250	408	400	360	344	254	-	20	90	14	175	190	245	42*	216-210
	B-NM 80/160E/A	100	80	125	605	180	225	340	125	95	320	250	60	-	65	14	165	193	375	15	108,5
4	B-NM 80/160D/A	100	80	125	685	180	225	365	125	95	320	250	50	-	65	14	165	193	430	15	116
	B-NM 80/160C/A	100	80	125	725	192	225	377	298	258	262	216	-	20	69	12	165	193	239	6	155
	B-NM 80/160B/A	100	80	125	800	192	225	377	298	258	262	216	-	20	69	12	165	193	239	6	175,5
4	B-NM 80/160A/A	100	80	125	800	192	225	377	298	258	262	216	-	20	69	12	165	193	239	6	182

Flange EN 1092-2

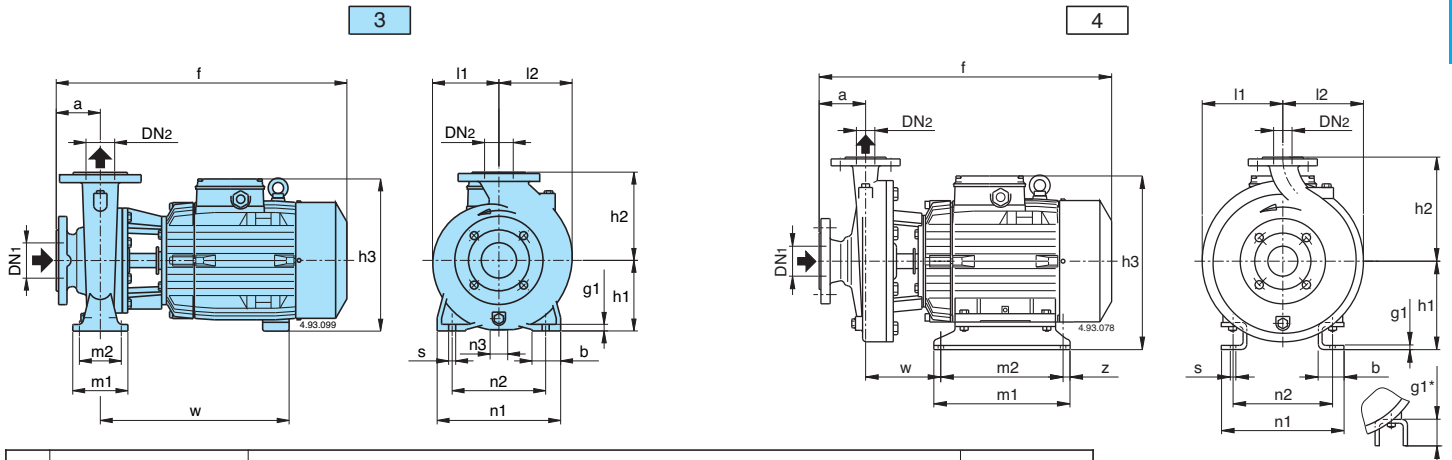
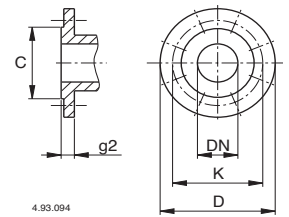

DN	C	K	D	Fori		g2
				N°	Ø	
32	76	100	140	4	19	18
40	84	110	150	4	19	18
50	99	125	165	4	19	20
65	118	145	185	4	19	20
80	132	160	200	8	19	22
100	156	180	220	8	19	24
125	184	210	250	8	19	24

Figura	B-NMS	mm																		kg										
		DN1	DN2	a	f1	f	h1	h2	h3	m1	m2	n1	n2	n3	z	b	b1	s	s1		l1	l2	w	w1	w2	g1				
2	B-NMS 65/250A	80	65	100	373	1032	200	250	505	160	120	360	280	318	-	80	83	18	19	175	190	406	355	305	-					
	B-NMS 80/200B	100	80	125	398	936	180	250	386	125	95	345	280	254	20	65	60	14	15	170	194	259	350	310	6					
	B-NMS 80/200A	100	80	125	398	936	180	250	386	355	305	388	318	254	20	83	60	19	15	170	194	259	350	310	6					
	B-NMS 80/250D-E	100	80	125	398	936	200	280	406	160	120	400	315	254	20	80	60	18	15	191	210	259	350	310	6					
	B-NMS 80/250C					1057			505					318					19							200	406	355	305	6
	B-NMS 80/250B	100	80	125	421	1130	225	280	550	260	220	410	315	356	-	80	80	18	19	225	225	445	361	286	-					
	B-NMS 80/250A				451	1198			642					24					275							275	619	409	349	-
	B-NMS 100/200E	125	100	125	398	857	200	280	411	160	120	360	280	216	20	80	60	18	15	180	212	259	350	310	6					
	B-NMS 100/200C-D					1057			505					318					19							200	406	355	305	6
	B-NMS 100/200B					1057			505					318					19							200	406	355	305	6
	B-NMS 100/200A	125	100	125	421	1130	250	280	550	260	220	410	315	356	-	80	80	18	19	225	225	445	361	286	-					
	B-NMS 100/250B					1213			250					642					24							275	275	494	409	349
B-NMS 100/250A	125	100	125	466	1286	280	712	642	260	220	410	315	457	-	80	100	18	24	275	275	516	479	368	-						